

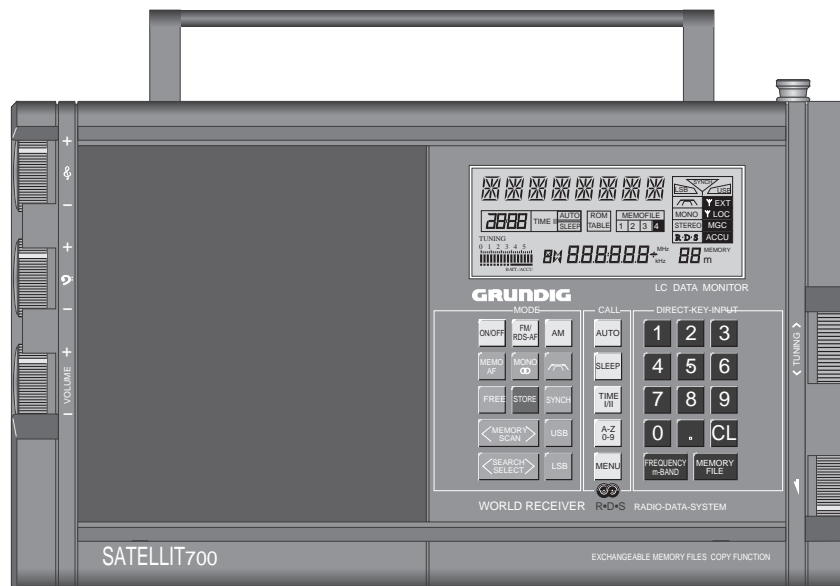

Satellit 700

Satellit 700 (9.15055-8151) / Satellit 700 USA (9.15055-7151) / Satellit 700 GB (9.15055-6251) / Satellit 700 Italia (9.15055-6151)



D

Inhaltsverzeichnis

	Seite
Technische Daten	2
Allgemeine Hinweise:	
Sicherheitshinweise	3-5
Sicherheitshinweise zu Lithiumbatterien	5
Chip-Technik	6-7
Behandlung von MOS-Bauteilen	7-8
Ausbauhinweise	9-10
Hinweise zum Satellit 700:	
Spannungsversorgung	11
Autom. Steuerung eines Cassettengerätes	12
Befestigen des Gerätes	12
Memofiles	12
Lautsprecher-Buchse	12
Synchrondetektor	13
RDS-Testmode	13
Testmode	14
Abgleich	15-18
Schaltbilder:	
HF-Platte	23-26
Prozessorplatte	27-30
Bedienplatte	35-37
NF- und Potiplatte	38-40
Druckplattenabbildungen:	
HF-Platte	19-22
Prozessorplatte	31-32
Bedienplatte	33-34
NF- und Potiplatte	41-42
Schaltbildhinweise	43
Ersatzteilliste	44-52

GB

Contents

	Page
Specification	2
General Notes:	
Safety Requirements	3-5
Safety Cautions for Lithium Batteries	5
Chip Technology	6-7
Handling of MOS Chip Components	7-8
Disassembly Instructions	9-10
Notes for the Satellit 700:	
Power Supply	11
Autom. Control of a Cassette Recorder	12
Securing the Unit	12
Memofiles	12
Loudspeaker Socket	12
Synchronous Demodulator	13
RDS-Testmode	13
Testmode	14
Alignment	15-18
Circuit Diagrams:	
RF Board	23-26
Processor Board	27-30
Operating Board	35-37
AF- and Potentiometer Board	38-40
Illustration of Printed Boards:	
RF Board	19-22
Processor Board	31-32
Operating Board	33-34
AF- and Potentiometer Board	41-42
Notes for the Circuit Diagram	43
List of Spare Parts	44-52

Technische Daten

Spannungsversorgung

- Durch Batterien:
4 x 1,5 V-Monozellen (IEC LR20) oder 4 x handelsübliche 4 Ah-Akkus in gleicher Größe (IEC KR 35/62).
Eingebaute, sich automatisch wiederaufladende Lithiumbatterie für Datensicherung.
- Externe Versorgung: Netzteil NR 90 oder Gleichspannung 9-12 V=

Ausgangsleistung (Mono und Stereo) an 7,5Ω

- Netz-/Musikleistung nach DIN 45324: 1 bzw. 2 x 1,5W
- Spitzenleistung: 1 bzw. 2 x 3W
- Sinusleistung bei Batteriebetrieb nach DIN 45324: 1 bzw. 2 x 0,5W

Batterie-Betriebsstunden (gemessen nach DIN 45314)

Typ IEC LR 20 (Alkali-Mangan)
z.B. VARTA energy 2000 ALKALINE: ca. 90 Std.
z.B. Duracell MN 1300: ca. 110 Std.
4 Ah-Accus (IEC KR 35/62): ca. 25 Std.

Eingebaute Antennen

- Teleskopantenne für UKW und Kurzwelle, Ferritstab-Antenne für MW und LW

Anschlußbuchsen

- zum Ansteuern von Verstärkeranlagen und für Mono- und Stereo-Überspielungen (Aufnahmen); LINE OUT (Cinch-Buchsen)
- für Kopfhörer mit 3,5-mm-Klinkenstecker; 32-2000Ω
- für Außenlautsprecher (linker und rechter Kanal) mit 3,5-mm-Klinkenstecker; 8Ω
- zum Steuern externer Geräte, z.B. Bandgeräte (Schaltausgangsbuchse) potentialfreie Relaisansteuerung
- für externe Spannungsversorgung; Netzteil NR 90 oder Gleichspannung 9-12V (5,5mm-Koaxial-Buchse)
- für Außenantenne DIN 45325 (FM 75Ω/AM 50Ω-Koaxial-Buchse für alle Bereiche)

Empfangsbereiche

FM: 87,5 - 108 MHz
SW: 1612 - 30000 kHz
3950 - 26100 kHz (Satellit Italia)
MW: 528 - 1611 kHz
LW: 150 - 353 kHz
150 - 302 kHz (Satellit Italia)

Empfangbare KW-Bänder

Band	Frequenz (kHz)
160-m-Amateur	1815 - 1890 (nicht bei Satellit Italia)
120-m-Rundfunk	2300 - 2498 (nicht bei Satellit Italia)
90-m-Tropen	3200 - 3400 (nicht bei Satellit Italia)
80-m-Amateur	3500 - 3800 (nicht bei Satellit Italia)
75-m-Rundfunk	3900 - 4000
60-m-Tropen	4750 - 5060
49-m-Rundfunk	5950 - 6200
41-m-Rundfunk	7100 - 7300
40-m-Amateur	7000 - 7099
31-m-Rundfunk	9500 - 9900
30-m-Amateur	10100 - 10150
25-m-Rundfunk	11650 - 12050
22-m-Rundfunk	13600 - 13800
20-m-Amateur	14000 - 14350
19-m-Rundfunk	15100 - 15600
17-m-Amateur	18065 - 18170
16-m-Rundfunk	17550 - 17900
15-m-Amateur	21000 - 21449
13-m-Rundfunk	21450 - 21850
12-m-Amateur	24890 - 24990
11-m-Rundfunk	25650 - 26100
10-m-Amateur	28000 - 29700 (nicht bei Satellit Italia)

ZF:

FM = 10,7 MHz
AM: ZF 1 = 54,5 MHz, ZF 2 = 450 kHz

Specification

Power supply requirement

- From batteries:
4 x 1.5 V "HP 2" (IEC LR20) or 4 commercially available 4 Ah accumulators of the same size (IEC KR 35/62).
Built-in automatically recharging lithium battery for data protection.
- From external voltage supply: Mains unit NR 90 or 9-12 V DC.

Output power (Mono and Stereo) in 7.5Ω

- Mains/music power according to DIN 45324: 1 and 2 x 1,5W, resp.
- Peak power: 1 and 2 x 3W, resp.
- Sinus power on battery operation acc.to DIN 45324: 1 and 2 x 0,5W, resp.

Batterie working hours (measured according to DIN 45314)

Typ IEC LR 20 (Alkali-Mangan)
e.g. VARTA energy 2000 ALKALINE: ca. 90 hours.
e.g. Duracell MN 1300: ca. 110 hours.
4 Ah-Accus (IEC KR 35/62): ca. 25 hours.

Built-in aerials

- Telescopic aerial for FM and SW, ferrite rod aerial for MW and LW.

Connecting sockets for

- driving amplifier systems and for mono and stereo tape recordings; LINE OUT (phono sockets)
- headphone with 3.5mm jack plug; 32-2000Ω
- external loudspeaker (left-hand and right-hand channel) with 3.5mm jack plug; 8Ω
- driving external units, e.g., tape recorders (output switch jack); potential-free relay control
- external power supply; mains unit NR 90 or 9-12V DC (5.5mm coaxial socket)
- external aerial DIN 45325 (FM 75Ω/AM 50Ω coaxial socket for all wavebands).

Wavebands

FM: 87.5 - 108 MHz
SW: 1612 - 30000 kHz
3950 - 26100 kHz (Satellit Italia)
MW: 528 - 1611 kHz
LW: 150 - 353 kHz
150 - 302 kHz (Satellit Italia)

Receivable SW Bands

Band	Frequency (kHz)
160-m-amateur	1815 - 1890 (not on Satellit Italia)
120-m-radio	2300 - 2498 (not on Satellit Italia)
90-m-tropic	3200 - 3400 (not on Satellit Italia)
80-m-amateur	3500 - 3800 (not on Satellit Italia)
75-m-radio	3900 - 4000
60-m-tropic	4750 - 5060
49-m-radio	5950 - 6200
41-m-radio	7100 - 7300
40-m-amateur	7000 - 7099
31-m-radio	9500 - 9900
30-m-amateur	10100 - 10150
25-m-radio	11650 - 12050
22-m-radio	13600 - 13800
20-m-amateur	14000 - 14350
19-m-radio	15100 - 15600
17-m-amateur	18065 - 18170
16-m-radio	17550 - 17900
15-m-amateur	21000 - 21449
13-m-radio	21450 - 21850
12-m-amateur	24890 - 24990
11-m-radio	25650 - 26100
10-m-amateur	28000 - 29700 (not on Satellit Italia)

IF:

FM = 10,7 MHz
AM: IF 1 = 54,5 MHz, IF 2 = 450 kHz

Allgemeine Hinweise

Sicherheitsvorschriften/Safety requirements/Prescrizioni de sicurezza/Prescriptions de sécurité/Prescripciones de seguridad

D **Achtung:** Bei Eingriffen ins Gerät sind die Sicherheitsvorschriften nach VDE 701 (reparaturbezogen) bzw. VDE 0860 / IEC 65 (gerätebezogen) zu beachten!

 Bauteile nach IEC- bzw. VDE-Richtlinien! Im Ersatzfall nur Teile mit gleicher Spezifikation verwenden!

MOS - Vorschriften beim Umgang mit MOS - Bauteilen beachten!

GB **Attention:** Please observe the applicable safety requirements according to VDE 701 (concerning repairs) and VDE 0860 / IEC 65 (concerning type of product)!

 Components to IEC or VDE guidelines! Only use components with the same specifications for replacement!

Observe **MOS** components handling instructions when servicing!

I **Attenzione:** Osservare le corrispondenti prescrizioni di sicurezza VDE 701 (concernente servizio) e VDE 0860 / IEC 65 (concernente il tipo di prodotto)!

 Componenti secondo le norme VDE risp. te IEC! In caso di sostituzione impiegare solo componenti con le stesse caratteristiche.

Osservare le relative prescrizioni durante, lavori con componenti **MOS**!

D

Sicherheitsbestimmungen

Nach Servicearbeiten ist bei Geräten der Schutzklasse II die Messung des Isolationswiderstandes und des Ableitstromes bei eingeschaltetem Gerät nach **VDE 0701 / Teil 200** bzw. der am Aufstellort geltenden Vorschrift, durchzuführen!

Dieses Gerät entspricht der Schutzklasse II, erkennbar durch das Symbol .

Wir empfehlen die Messungen mit dem **METRATESTER 3/4** durchzuführen. (Meßgerät zur Prüfung elektrischer Geräte nach VDE 0701).

Metrawatt GmbH
Geschäftsstelle Bayern
Triebstr. 44
D 8000 München 50

Ist die Sicherheit des Gerätes nicht gegeben, weil

- eine Instandsetzung unmöglich ist
 - oder der Wunsch des Benützers besteht, die Instandsetzung nicht durchführen zu lassen,
- so muß dem Betreiber die vom Gerät ausgehende Gefahr schriftlich mitgeteilt werden.

GB

Safety Standard Compliance

After service work on a product conforming to the Safety Class II, the insulating resistance and the leakage current with the product switch on must be checked according to VDE 0701 or to the specification valid at the installation location!

This product conforms to the Safety Class II, as identified by the symbol .

We recommend that the measurements are carried out using the **METRATESTER 3/4**. (Test equipment for checking electrical products to VDE 0701).

Metrawatt GmbH
Geschäftsstelle Bayern
Triebstr. 44
D 8000 München 50

If the safety of the product is not proved, because

- a repair and restoration is impossible
 - or the request of the user is that the restoration is not to be carried out,
- the operator of the product must be warned of the danger by a written warning.

General Notes

F **Attention:** Priere d`observer les prescriptions de securite VDE 701 (concernant les reparations) et VDE 0860 / IEC 65 (concernant le type de produit)!

 Composants répondant aux normes VDE ou IEC. Les remplacer uniquement par des composants ayant les memes spécifications.

Lors de la manipulation des circuits **MOS**, respecter les prescriptions **MOS**!

E **Atención:** Recomendamos las normas de seguridad VDE u otras normas equivalentes, por ejemplo: VDE 701 para reparaciones, VDE 0860 / IEC 65 para aparatos!

 Componentes que cumplen las normas VDE/IEC. En caso de sustitución, emplear componentes con idénticas especificaciones!

Durante la reparacion observar las normas sobre componentes **MOS**!

USA **Attention:** This set can only be operated from AC mains of 120 V/60 Hz. Also observe the information given on the rear of the set.

 CAUTION-for continued protection against risk of fire replace only with same type fuses!

CAUTION: to reduce the risk of electric shock, do not remove cover (or back), no user-serviceable parts inside, refer servicing to qualified service personnel. Observe **MOS** components handling instructions when servicing!

Empfehlungen für den Servicefall

- Nur Original - Ersatzteile verwenden.
Bei Bauteilen oder Baugruppen mit der Sicherheitskennzeichnung  sind Original - Ersatzteile zwingend notwendig.
- Auf Sollwert der Sicherungen achten.
- Zur Sicherheit beitragende Teile des Gerätes dürfen weder beschädigt noch offensichtlich ungeeignet sein.
- Dies gilt besonders für Isolierungen und Isolierteile.
- Netzleitungen und Anschlußleitungen sind auf äußere Mängel vor dem Anschluß zu prüfen. Isolation prüfen!
- Die Funktionssicherheit der Zugentlastung und von Biegeschutz-Tüllen ist zu prüfen.
- Thermisch belastete Lötstellen absaugen und neu löten.
- Belüftungen frei lassen.

Recommendation for service repairs

- Use only original spare parts.
With components or assemblies accompanied with the Safety Symbol  only original-spare parts are strictly to be used.
- Use only original fuse value.
- Safety compliance, parts of the product must not be visually damaged or unsuitable. This is valid especially for insulators and insulating parts.
- Mains leads and connecting leads should be checked for external damage before connection. Check the insulation!
- The functional safety of the tension relief and bending protection bushes are to be checked:
- Thermally loaded solder pads are to be suck off and re-soldered.
- Ensure that the ventilation slots are not obstructed.

F**Prescriptions de securite**

Suite aux travaux de maintenance sur les appareils de la classe II, il convient de mesurer la résistance d'isolement et le courant de fuite sur l'appareil en état de marche, conformément à la norme VDE 0701 § 200, ou selon les prescriptions en vigueur sur le lieu de fonctionnement de l'appareil!

Cet appareil est conforme aux prescriptions de sécurité classe II, signalé par le symbole .

Pour ces mesures, nous préconisons l'utilisation du **METRA-TESTER 3/4** (instrument de mesure pour le contrôle d'appareils électriques conformes à la norme VDE 0701).

METRAWATT GmbH
Geschäftsstelle Bayern
Triebstr. 44
D 8000 München 50

Dans le cas où la sécurité de l'appareil n'est pas assurée pour les raisons suivantes:

- la remise en état est impossible
 - l'utilisateur ne souhaite pas la remise en état de l'appareil.
- l'utilisateur doit être informé par écrit du danger que représente l'utilisation de l'appareil.

Recommandations pour la maintenance

- Utiliser exclusivement des pièces de rechange d'origine. Les composants et ensembles de composants signalés par le symbole  doivent être impérativement remplacés par des pièces d'origine.
- Respecter la valeur nominale des fusibles.
- Veiller au bon état et la conformité des pièces contribuant à la sécurité de fonctionnement de l'appareil. Ceci s'applique particulièrement aux isolements et pièces isolantes.
- Vérifier le bon état extérieur des câbles secteur et des câbles de raccordement au point de vue isolement avant la mise sous tension.
- Vérifier le bon état des protections de gaine.
- Nettoyer les soudures avant de les renouveler.
- Dégager les voies d'aération.

I**Norme di sicurezza**

Successivamente ai lavori di riparazione, negli apparecchi della classe di protezione II occorre effettuare la misura della resistenza di isolamento e della corrente di dispersione quando l'apparecchio è acceso, secondo le norme VDE 0701 / parte 200 e rispettivamente le norme locali!

Questo apparecchio corrisponde alla classe di protezione II ed è riconoscibile dal simbolo .

Si raccomanda di effettuare le misure con lo strumento **METRA-TESTER 3/4** (strumento di misura per il controllo di apparecchi elettrici secondo VDE 0701).

Metrawatt GmbH
Geschäftsstelle Bayern
Triebstr. 44
D 8000 München 50

Se la sicurezza dell'apparecchio non è raggiunta, perchè

- una riparazione non è possibile
- oppure è desiderio del cliente che una riparazione avvenga in questi casi si deve comunicare per iscritto all'utilizzatore.

la pericolosità dell'apparecchio riguardo il suo isolamento.

Raccomandazione per il servizio assistenza

- Impiegare solo componenti originali:
I componenti o i gruppi di componenti contraddistinti dall'indicazione  devono assolutamente venir sostituiti con parti originali.
- Osservare il valore nominale dei fusibili.
- I componenti che concorrono alla sicurezza dell'apparecchio non possono essere né danneggiati né risultare visibilmente inadatti. Questo vale soprattutto per isolamenti e parti isolate.
- I cavi di rete e di collegamento vanno controllati prima dell'utilizzo affinché non presentino imperfezioni esteriori. Controllare l'isolamento.
- È necessario controllare la sicurezza dei fermacavi e delle guaine flessibili.
- Saldature caricate termicamente vanno rifatte.
- Lasciare libere le fessure di areazione.

E**DISPOSICIONES PARA LA SEGURIDAD**

Después de operaciones de servicio en aparatos de la clase de protección II, se llevará a cabo la medida de la resistencia de aislamiento y de la corriente derivada, con el aparato conectado, de acuerdo con VDE 0701 o de las disposiciones vigentes en el lugar de instalación.

Este aparato corresponde a la clase de protección II, reconocible por el símbolo .

Aconsejamos llevar a cabo las medidas con el **METRA-TESTER 3/4** (Instrumento de medida para la comprobación de aparatos eléctricos según VDE 0701).

METRAWATT GmbH
Geschäftsstelle Bayern
Triebstr. 44
D 8000 München 50

Si no se cumple la seguridad del aparato, porque

- la puesta en orden es imposible, o
- existe el deseo del usuario de no realizarla, se ha de comunicar a quien lo haga funcionar, por escrito, del peligro dimanante del aparato.

Recomendaciones para caso de servicio

- Emplear sólo componentes originales.
Con componentes o grupos constructivos con el indicativo de seguridad  son de obligada necesidad piezas de repuesto originales.
- Las partes del aparato que contribuyan a la seguridad del mismo no deben estar deterioradas ni ser manifiestamente inadecuadas.
- Esto es especialmente válido para aislamientos o piezas aislantes.
- Los cables de red y de conexión se comprobarán, antes de conectarlos, en cuanto a defectos externos. Comprobar el aislamiento.
- Se ha de comprobar la función de seguridad de la compensación de tiro o de los manguitos de protección contra doblamientos.
- Repasar los puntos de soldadura sometidos a carga térmica.
- Mantener libres los canales de aireación.

U.S. &
Canada**Safety Instructions**

The lightning flash with arrowhead symbol, within an equilateral triangle, is intended to alert the user to the presence of uninsulated "dangerous voltage", within the product's enclosure that may be of sufficient magnitude to constitute a risk of electric shock to persons.



The exclamation point within an equilateral triangle is intended to alert the user to the presence of important operating and maintenance (servicing) instructions in the literature accompanying the appliance.

This product was designed and manufactured to meet strict quality and safety standards. There are, however, some installation and operation precautions which you should be particularly aware of.

- Read Instructions - All the safety and operating instructions should be read before the appliance is operated.
- Retain Instructions - The safety and operating instructions should be retained for future reference.
- Heed Warnings - All warnings on the appliance and in the operating instructions should be adhered to.
- Follow Instructions - All operating and use instructions should be followed.
- Water and Moisture - The appliance should not be used near water-for example, near a bathtub, washbowl, kitchen sink, laundry tub, in a wet basement, or near a swimming pool, and the like.
- Wall or Ceiling Mounting - The appliance should be mounted to wall or ceiling only as recommended by the manufacture.
- Ventilation - The appliance should be situated so that its location or position does not interfere with its proper ventilation. For example, the appliance should not be situated on a bed, sofa, rug, or similar surface that may block the ventilation openings; or, placed in a built-in installation, such as a bookcase or cabinet that may impede the flow of air through the ventilation openings.
- Heat - The appliance should be situated away from heat sources such as radiators, heat registers, stoves, or other appliances (including amplifiers) that produce heat.

- Power Sources - The appliance should be connected to a power supply only of the type given above or as marked on the appliance.
- Power-Cord Protection - Power-supply cords should be routed so that they are not likely to be walked on or pinched by items placed upon or against them, paying particular attention to cords at plugs, convenience receptacles, and the point where they exit from the appliance.
- Cleaning - The appliance should be cleaned only as recommended by the manufacturer.
- Power Lines - An outdoor antenna should be located
 - x1 away from power lines.
- Outdoor Antenna Grounding - If an outside antenna is
 - x2 connected to the receiver, be sure the antenna system is grounded so as to provide some protection against voltage surges and built up static charges. Section 810 of the National Electrical Code, ANSI / NFPA No. 70-1984, provides information with respect to proper grounding of the mast and supporting structure, grounding of the lead-in wire to an antenna discharge unit, size of grounding conductors, location of antenna discharge unit, connection to grounding electrodes, and requirements for the grounding electrode.
- Nonuse Periods - The power cord of the appliance should be unplugged from the outlet when left unused for a long period of time.
- Object and Liquid Entry - Care should be taken so that objects do not fall and liquids are not spilled into the enclosure through openings.
- Damage Requiring Service - The appliance should be serviced by qualified service personnel when: The power-supply cord or the plug has been damaged; or objects have fallen, or liquid has been spilled into the appliance; or the appliance has been exposed to rain; or the appliance does not appear to operate normally or exhibits a marked change in performance; or the appliance has been dropped, or the enclosure damaged; or the batteries have been damaged.
- Servicing - the user should not attempt to service the appliance beyond that described in the operating instructions. All other servicing should be referred to qualified service personnel. Items x1 and x2 apply only to receivers or tuners.

**Sicherheitshinweise zu Lithium-Batterien****Vorsicht bei Lithium-Batterien:**

Bei falscher Handhabung (Überhitzung, Falschpolung oder Kurzschluß) der Lithium-Batterien besteht Explosionsgefahr!

Lithium-Batterien dürfen **nur** gegen **Original-Ersatzteile** (s. Ersatzteilliste) getauscht werden.

U.S. &
Canada**Safety cautions for Lithium Batteries****Warning! Lithium Batteries:**

Wrongly used lithium batteries (excessive heat, wrong connection of terminals, short circuit) represent a danger of explosion!

Lithium batteries must be replaced **only** by **original spare parts** (see Spare Parts List).

Please observe the appropriate disposal regulations for exhausted lithium batteries.

**Varning**

Eksplisionsfara vid felaktigt batteritype. Använd samma batterityp eller en ekvivalent typ som rekommenderas av apparattillverkaren.

Kassera använt batteri enligt fabrikantens instruktion.

**Varoitus**

Paristo voi räjähtää, jos se on virheellisesti asennettu.

Vaihda paristo ainoastaan laitevalmistajan suosittelemaan tyyppiin. Hävitä käytetty paristo valmistajan ohjeiden mukaisesti.

**Advarsel!**

Lithiumbatteri - eksplosionsfare ved fejlagtig håndtering. Udskiftning må kun ske med batteri af samme fabrikat og type.

Levér det brugte batteri til de offentlige indsamlingssteder.

Udskiftning må kun foretages af en sagkyndig, og som beskrevet i servicemanualen.

D CHIP Technik

Aus- und Einlöten von CHIP-Bauteilen

- Verwenden Sie nur einen NiedervoltlötKolben mit Temperaturregelung.
- Die Löttemperatur sollte ca. 240 °C betragen (max. 300 °C).
- Halten Sie die Lötzeit so kurz wie möglich.
- Belassen Sie CHIP-Bauteile bis zur Bearbeitung in der Originalverpackung. Damit wird die Oxidation der Stirnkontakte vermieden.
- Berühren Sie CHIP-Bauteile nicht mit der bloßen Hand.

Auslöten von CHIP-Bauteilen

1. Schritt: CHIP- Lötstelle mit Sauglitze absaugen (Fig. 1).
2. Schritt: CHIP-Enden, bzw. das komplette CHIP-Bauteil erwärmen. CHIP von der Klebung ohne Kraftaufwand abdrehen, damit unter dem CHIP liegende Leiterbahnen nicht abgerissen werden (Fig. 2).

Achtung!

**Ausgelötetes CHIP nicht wiederverwenden!
Die leitende Schicht kann ausgebrochen sein.**

Einlöten von CHIP-Bauteilen

3. Schritt: Lötspunkt von Lötrückständen säubern. Lötperle anbringen (Fig. 3).
4. Schritt: CHIP an der Lötstelle ansetzen, zentrieren und anlöten (Fig. 4).
5. Schritt: Freie Seite löten. Nach dem Erkalten die erste Lötstelle nochmals nachlöten (Fig. 5).

I Tecnica CHIP

Saldatura e dissaldatura di componenti MOS

- Impiegare un saldatore a basso voltaggio con regolazione della temperatura.
- Temperatura del saldatore: ca. 240 °C (valore massimo 300 °C).
- Il tempo di saldatura deve essere il più breve possibile.
- Il componente CHIP deve rimanere nell'imballaggio originale fino al momento del suo impiego per evitare che le superfici di contatto si ossidino.
- Non toccare i componenti CHIP con mani nude.

Dissaldatura di un CHIP

1. Aspirare i punti di saldatura del CHIP con una calza dissaldante (Fig. 1).
2. Riscaldare le superfici di contatto del CHIP risp. te tutto il CHIP e staccarlo con cautela. Attenzione a non esercitare forza per non danneggiare le piste sottostanti (Fig. 2).

Attenzione!

Non impiegare più il CHIP dissaldato, perchè il corpo elettrico può presentare delle rotture.

Saldatura di un CHIP

3. Pulire il punto dai residui di saldatura. Applicare una goccia di stagno (Fig. 3).
4. Appoggiare il CHIP sul punto di saldatura, centrarlo e quindi saldarlo (Fig. 4).
5. Saldare la superfici di contatto libera e, dopo che questa si è raffreddata, saldare nuovamente la superfici opposta (Fig. 5).

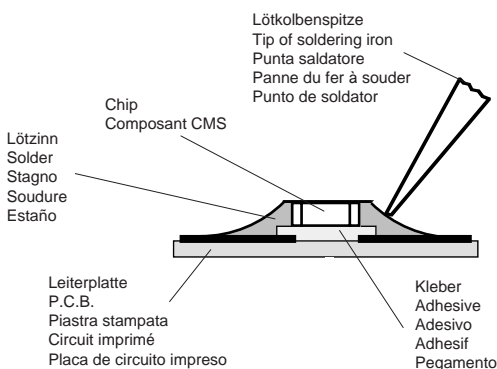

Fig. 1

GB CHIP Technology

Soldering and unsoldering of CHIP components

- Use only low-voltage soldering irons with temperature control.
- Permissible soldering temperatures are approx. 240 °C up to max. 300 °C.
- Keep the soldering period as short as possible.
- Keep the CHIP components in their original packages until they are used to avoid oxidation of the end contacts.
- Do not touch CHIP components with bare hands.

Unsoldering of CHIP components

1. step: Clean the CHIP soldering point with a solder wick (Fig. 1).
2. step: Warm up the ends of the CHIP or the whole CHIP component and remove the CHIP from the adhesive by turning it without application of force so that the tracks beneath the CHIP do not break (Fig. 2).

Attention!

**Do not use unsoldered CHIPS any more!
The conductive layer may be broken.**

Soldering of CHIP components

3. step: Remove possible residues from the soldering point. Then apply a solder bead (Fig. 3).
4. step: Put the CHIP onto the soldering point, then center and fix it (Fig. 4).
5. step: Solder the free end of the CHIP and resolder the first soldering point after it has cooled (Fig. 5).

F Technologie CMS

Soudure des composants CMS

- Utiliser exclusivement un fer à souder à basse tension et réglage thermique
- La température de soudure doit être de 240 °C environ (max. 300 °C).
- L'opération doit être très brève.
- Conserver les composants CMS dans leur emballage d'origine jusqu'au moment de leur utilisation, ceci pour éviter l'oxydation des contacts externes.
- Ne pas toucher les composants CMS à la main nue.

Dessoudage des composants CMS

1. Aspirer la soudure du composant CMS à la l'aide de la tresse à souder (Fig. 1).
2. Chauffer légèrement les contacts externes du composant CMS ou le composant lui-même. Retirer ce dernier avec précaution en le tournant afin d'éviter un arrachement des circuits imprimés situés sous le composant (Fig. 2).

Attention!

Ne pas réutiliser les composants CMS, la face conductrice pouvant être endommagée.

Soudure des composants CMS

3. Aspirer les restes de soudure sur le circuit. Poser une pointe de soudure (Fig. 3).
4. Poser le composant CMS sur cette pointe de soudure, centrer et souder. Maintenir le composant CMS à l'aide d'une pince brucelle (Fig. 4).
5. Effectuer la même opération pour l'autre coté. Terminer la première soudure (Fig. 5).

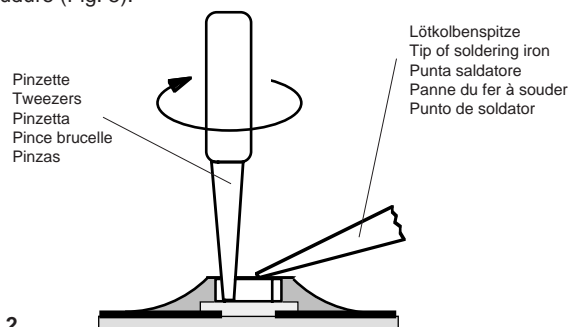

Fig. 2

E Técnica de CHIP's

Soldaje y desoldaje de CHIP's

- Emplear sólo un soldador de bajo voltaje con regulación de temperatura.
- La temperatura del soldador debe ser de aprox. 240 °C (máx. 300 °C).
- El tiempo de soldadura debe de ser lo más corto posible.
- Dejar los componentes CHIP hasta su montaje en el embalaje original. Con ello se evita la oxidación de los contactos frontales.
- No tocar con las manos los componentes CHIP.

Desoldaje de un CHIP

Primer paso: Aspirar el estaño del punto de soldadura con un aspirador de los tipos de pera o de resorte (Fig. 1).

Segundo paso: Calentar los extremos o todo el CHIP y girarlo con las pinzas. No hacer fuerza para que la placa de circuito impreso no resulte dañada. Cuidar de que las pistas situadas debajo del CHIP no se suelten de la placa, ya que éstas también están pegadas (Fig. 2).

Cuidado!

No volver a utilizar el CHIP desoldado. La capa eléctrica puede estar interrumpida.

Soldadura de CHIP's

- Tercer paso: Limpiar el punto de soldadura de residuos de la soldadura anterior. Poner una gota de estaño (Fig. 3).
- Cuarto paso: Colocar el CHIP sobre la gota de estaño, centrarlo y soldarlo (Fig. 4).
- Quinto paso: Soldar la parte libre y, después enfriarse, soldar también la parte opuesta (Fig. 5).

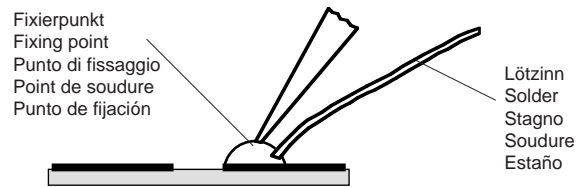

Fig. 3

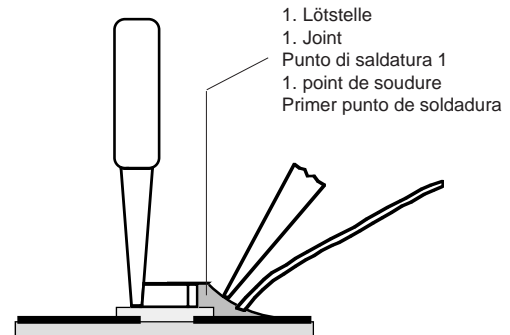

Fig. 4

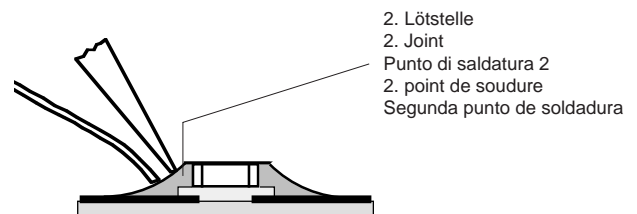

Fig. 5

D

Behandlung von MOS - Bauelementen

Schaltungen in MOS-Technik bedürfen besonderer Vorsichtsmaßnahmen gegenüber statischer Aufladung. Statische Aufladungen können an allen hochisolierenden Kunststoffen auftreten und auf den Menschen übertragen werden, wenn Kleidung und Schuhe aus synthetischem Material bestehen.

Schutzstrukturen an den Ein- und Ausgängen der MOS-Schaltungen geben wegen ihrer Ansprechzeit nur begrenzte Sicherheit.

Bitte beachten Sie folgende Regeln, um Bauelemente vor Beschädigung durch statische Aufladungen zu schützen:

1. MOS-Schaltungen sollen bis zur Verarbeitung in elektrisch leitenden Verpackungen verbleiben. Keinesfalls MOS-Bauteile in Styropor oder Plastikschienen lagern oder transportieren.
2. Personen müssen sich durch Berühren eines geerdeten Gegenstandes entladen, bevor sie MOS-Bauteile anfassen.
3. MOS-Bauelemente nur am Gehäuse anfassen, ohne die Anschlüsse zu berühren.
4. Prüfung und Bearbeitung nur an geerdeten Geräten vornehmen.
5. Lösen oder kontaktieren Sie MOS-ICs in Steckfassungen nicht unter Betriebsspannung.
6. Bei p-Kanal-MOS-Bauelementen dürfen keine positiven Spannungen (bezogen auf den Substratanschluß VSS) an die Schaltung gelangen.

Lötvorschriften für MOS-Schaltungen:

- Nur netzgetrennte NiedervoltlötKolben verwenden.
- Maximale Lötzeit 5 Sekunden bei einer LötKolbentemperatur von 300 °C bis 400 °C.

GB

Handling of MOS Chip Components

MOS circuits require special attention with regard to static charges. Static charges may occur with any highly insulating plastics and can be transferred to persons wearing clothes and shoes made of synthetic materials.

Protective circuits on the inputs and outputs of MOS circuits give protection to a limited extent only due to the time of reaction.

Please observe the following instructions to protect the components against damages from static charges:

1. Keep MOS components in conductive packages until they are used. MOS components must never be stored or transported in Styropor materials or plastic magazines.
2. Persons have to rid themselves of electrostatic charges by touching a grounded object before handling MOS components.
3. Take the chip by the body without touching the terminals.
4. Use only grounded instruments for testing and processing purposes.
5. Remove or connect MOS ICs with in mounting sockets only if the operating voltage is disconnected.
6. The circuits of p-channel MOS components must not be connected to positive voltages (with reference to bulk VSS).

MOS Soldering Instructions

- Use only mains isolated low-voltage soldering irons.
- Maximum soldering period 5 seconds at a soldering iron temperature of 300 to 400 degrees Celsius.

I

Impiego dei componenti MOS

I circuiti in tecnica MOS necessitano di una particolare attenzione per evitare le scariche elettrostatiche.

Tutti i materiali sintetici ad alto potere isolante possono caricar si staticamente e queste cariche possono trasmettersi all'uomo, particolarmente se scarpe o vestiti sono sintetici.

Le strutture di sicurezza sull'ingresso e sull'uscita dei circuiti MOS hanno un'efficacia limitata a causa del loro periodo di intervento.

Per proteggere i componenti MOS dalle scariche elettrostatiche si consiglia di adottare le seguenti precauzioni:

1. Fino al momento del loro impiego, i MOS devono restare in materiale elettricamente conduttivo. Non trasportarli o depositarli mai in listelli di plastica o in polistirolo.
2. Le persone che maneggiano i componenti MOS devono prima scaricar si elettrostaticamente toccando un oggetto con collegamento a massa.

3. Maneggiare i componenti MOS toccandone solo l'involucro e mai i piedini.

4. Controlli e lavorazioni devono avvenire soltanto su apparecchi con messa a terra.

5. Non inserire e non staccare mai gli integrati MOS dagli zoccoli quando la tensione di alimentazione è collegata.

6. Ai componenti MOS canale P non devono giungere tensioni positive (rif. a collegamento del substrato VSS).

Norme di taratura per gli integrati MOS:

- Impiegare solo saldatori a bassa tensione con separazione dalla rete.
- Il tempo massimo di saldatura è di 5 sec. con una temperatura del saldatore compresa fra 300 °C e 400 °C.

F

Précautions à prendre pour la manipulation des circuits MOS

Les circuits équipés en technique MOS exigent des précautions particulières contre les charges statiques.

Des charges statiques peuvent se créer sur toutes les matières synthétiques à fort pouvoir isolant, elles peuvent se transmettre au corps humain et le risque est d'autant plus important si la personne porte des vêtements ou des chaussures en matière synthétique.

Les systèmes de protection dont sont équipées les entrées et sorties des circuits MOS n'apportent qu'une sécurité limitée du fait de leur temps de fonctionnement.

Afin de protéger les composants contre les charges statiques, il est recommandé d'observer les règles suivantes:

1. Les circuits MOS doivent rester placés dans un matériel conducteur jusqu'au moment de leur utilisation. Il ne doivent en aucun cas être stockés ou transportés dans du styropore ou sur des bandes de plastique.
2. Les personnes travaillant sur des circuits MOS doivent au préalable se décharger de leur charge statique en touchant un objet mis à terre.

3. Les ensembles équipés de circuits MOS doivent être saisis uniquement par leur boîtier, on ne doit pas toucher les broches de raccordement.

4. On ne doit effectuer de contrôles et travaux que sur des appareils mis à la terre.

5. Ne jamais retirer ou raccorder un circuit MOS sur un appareil sous tension.

6. Les circuits MOS canal p ne doivent en aucun cas recevoir de tensions positives (en VSS par rapport à la liaison vers le substrat).

Prescription de soudure sur les circuits MOS

- N'utiliser que des fers à souder basse tension isolés du secteur
- Temps de soudure maximum : 5 secondes pour une température comprise entre 300 °C et 400 °C.

E

Tratamiento de componentes en técnica MOS

Los circuitos contruidos en técnica MOS precisan un cuidado especial contra las cargas estáticas.

En todos los materiales plásticos de elevado aislamiento pueden aparecer cargas estáticas y también ser transmitidas a la personas, especialmente cuando las ropas y zapatos son de materia sintética. Las estructuras de protección en las entradas y salidas de los integrados MOS, debido a su tiempo de conexión, proporcionan sólo una limitada seguridad.

Para proteger los módulos de las descargas estáticas es aconsejable prestar atención a las siguientes reglas:

1. Los circuitos integrados MOS deben permanecer envueltos en un material conductor hasta el momento de su empleo. En ningún caso se les colocará ni transportará en recipientes de styropor o guías de plástico.
2. Las personas que trabajan con elementos MOS deben descargarse previamente tocando un objeto puesto a tierra.

3. Los elementos MOS sólo deben cogerse por la cápsula, sin rozar siquiera los terminales.

4. Pruebas y trabajos con los circuitos MOS sólo deben realizarse en aparatos que estén puestos a tierra.

5. No extraer ni establecer contacto bajo tensión de funcionamiento de los IC's MOS enchufables.

6. En los componentes MOS canal-p no deben llegar tensiones positivas (con respecto a la tensión de substrato VSS) a los circuitos.

Prescripciones para la soldadura de los circuitos integrados MOS:

- Utilizar únicamente soldadores de baja tensión con transformador-separador de la red.
- Tiempo máximo de soldadura: 5 segundos con una temperatura entre 300 y 400 °C.

Ausbauhinweise

Disassembly Instructions

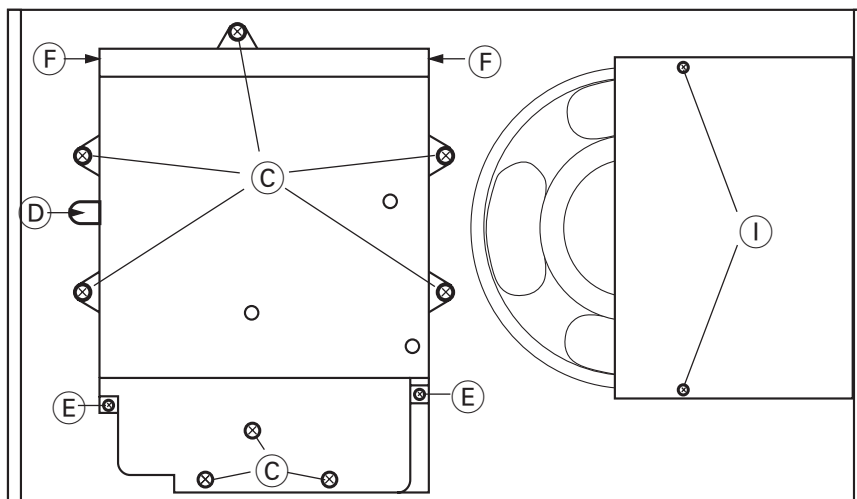
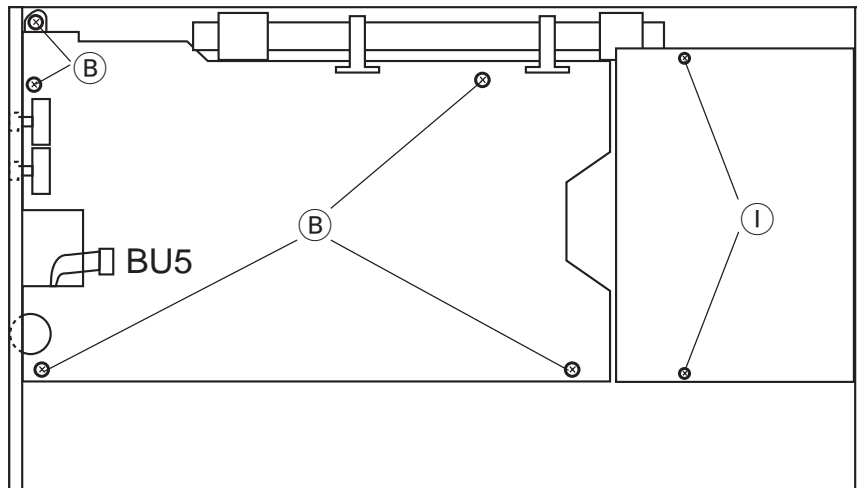
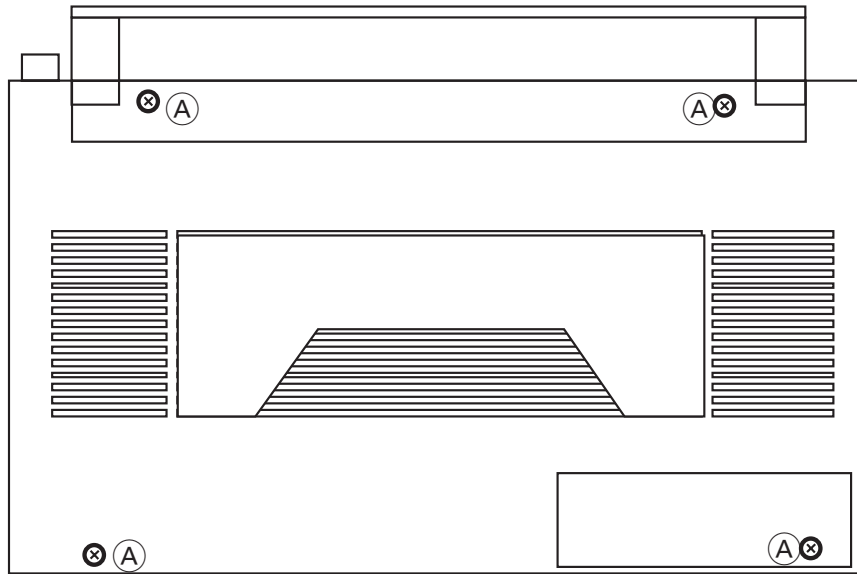

Rückwand

- 4 Schrauben (A) herausschrauben.
- Rückwand an der Bodenseite anheben und vorsichtig aufklappen. Plusleitung der Batterie abziehen.

HF - Platte

- 5 Schrauben (B) herausschrauben.
- Steckverbindung BU5 lösen.
- HF-Platte rechts anheben.
- Achtung:** Ferritantenne an der NF-Platte vorbeiführen. HF-Platte etwas nach rechts ziehen, bis sie an der linken Seite hochgeklappt werden kann. In dieser Stellung ist das Gerät funktionsfähig!
- Die restlichen Steckverbindungen abziehen.
- HF-Platte herausnehmen.

Digitalbaustein

- HF - Platte ausbauen.
- Handradanschlüsse ablöten
- 8 Schrauben (C) herausschrauben.
- Steckverbindung zur NF-Platte lösen.
- Digitalbaustein herausnehmen.
- Achtung:** Unter dem Abschirmblech ist bei (D) eine Feder!
- Digitalbaustein öffnen
- 2 Schrauben (E) herausschrauben.
- 2 Halter (F) aufbiegen.
- Platten voneinander abziehen.

NF - Platte und Potentiometerplatte

- 3 Knöpfe (G) abziehen.
- 3 Muttern (H) abschrauben.
- 2 Schrauben (I) herausschrauben.
- Lautsprecherleitung ablöten.
- Steckverbindungen lösen.
- Masseleitung zum Lautsprechergitter ablöten.
- Beim Einbau darauf achten, daß der LOCK-Schalter in den Schalterknopf eingreift.

Displaybeleuchtung

- Digitalbaustein ausbauen und öffnen.
- Displaylampen auslöten.

Rear Panel.

- Unscrew 4 screws (A).
- Lift the rear panel at the bottom side and remove it carefully.
- Disconnect the battery plus wire.

RF Board

- Unscrew 5 screws (B).
- Disconnect the plug-in connection BU5.
- Lift the RF board at the right side.
- Attention:** Move the ferrite antenna past the AF board. Move the RF board to the right, so that its left side can be tipped up. In this position the unit is functional!
- Disconnect the remaining plug-in connections.
- Remove the RF board.

Digital Unit

- Remove the RF board.
- Unsolder the connection to the hand wheel.
- Unscrew the 8 screws (C).
- Disconnect the plug-in connection to the AF board.
- Remove the digital unit.
- Attention:** Under the shield there is a spring at (D).
- Opening of the Digital Unit
- Unscrew 2 screws (E).
- Bend up the 2 holders (F).
- Dismantle the boards.

AF Board and Potentiometer Board

- Pull off the 3 knobs (G).
- Unscrew the 3 hexagon nuts (H).
- Unscrew the 2 screws (I).
- Unsolder the line to the loudspeaker.
- Disconnect the plug-in connections.
- Unsolder the line to the loudspeaker grill.
- When reassembling take care that the LOCK switch engages with its button.

Display illumination

- Remove the digital unit and open it.
- Unsolder the display lamps.

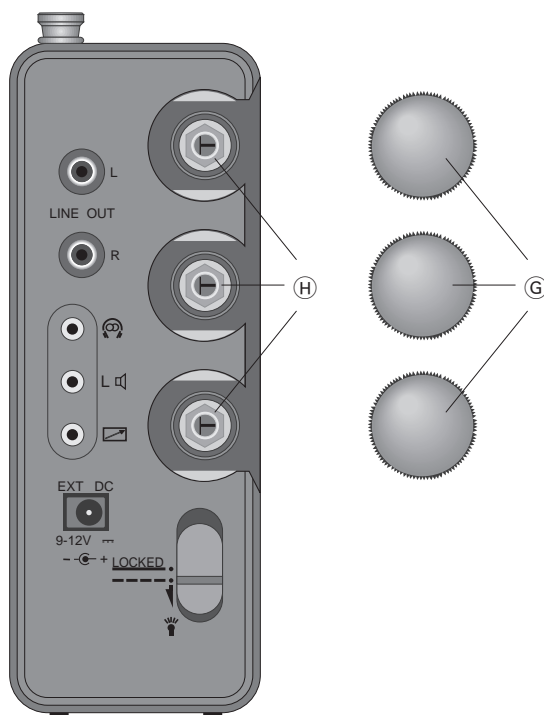



Hinweise zum Satellit 700

Spannungsversorgung

Batterie- bzw. Accu-Betrieb

Mit 4 Monozellen IEC LR 20 (Alkali-Mangan-Batterien) bzw. handelsüblichen Ni Cd-Accus gleicher Größe.

- Verwenden Sie nur Accus mit dem Aufdruck 1,24V und 4000 mAh.
- Setzen Sie die Batterien bzw. Accus polarisationsrichtig ein
- **Achtung:** Bei Batteriebetrieb muß der Schiebeschalter ACCU/BATT. (im Batteriefach) in Stellung BATT. stehen. Niemals bei eingesetzten Batterien den Schalter auf ACCU stellen bzw. stehen lassen (Anzeige ACCU).

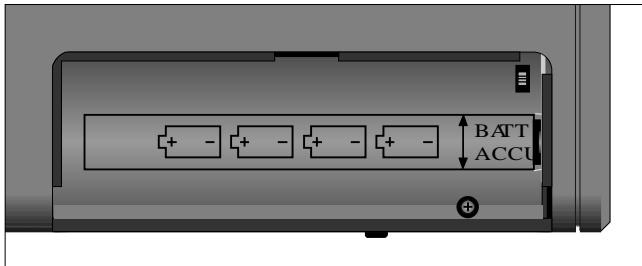

Für Schäden, die durch unsachgemäßes Benutzen der Ladeeinrichtung entstehen, kann keine Haftung übernommen werden.

- Bei Verwendung von Ni Cd-Accus bringen Sie den Schalter in Stellung ACCU (Anzeige ACCU).

Ladezeit

Je nach Ladezustand der Accus kann mit dem Netzteil NR90 eine Ladezeit von bis zu 4 Tagen notwendig werden (bei ausgeschaltetem Gerät). Durch die eingebaute Ladeschaltung können die Accus auch bei ständig angeschlossenem Ladegerät NR90 nicht überladen werden.

Läßt sich das Gerät nicht einschalten, oder blinkt nach dem Einschalten nur die Frequenzanzeige kurz auf, dann ist die Betriebsspannung zu gering. In diesem Fall ist der komplette Batteriesatz zu wechseln bzw. sind die Accus nachzuladen.

- Verbrauchte Batterien sofort herausnehmen!
- Während längerer Betriebspausen auch neue Batterien aus dem Gerät nehmen!

Für Schäden, die durch auslaufende Batterien entstehen, kann nicht gehaftet werden.

RESET-Taste

Sollte durch äußere Störeinflüsse (hervorgerufen durch statische Aufladungen von Teppichböden oder aufgrund von Gewittern usw.), die Bedienelektronik des Satellit 700 Fehlinformationen bekommen, bzw. die Eingabe völlig blockiert sein, so betätigen Sie die RESET-Taste in der MEMOFILE-Box mit einem spitzen Gegenstand.

Das Gerät wird dadurch in eine Grundprogrammierung zurückgesetzt. Stationsspeicher werden nicht gelöscht.

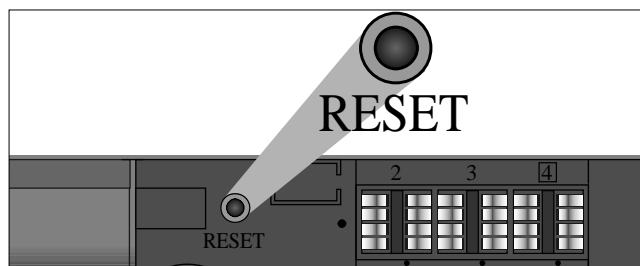

Datensicherung

Durch eine auf der Bedienplatte eingebaute, aufladbare Stützbatterie (Lithiumbatterie, wird automatisch aufgeladen, wenn das Gerät betriebsbereit ist) bleiben nach dem Ausschalten alle Speicherinhalte erhalten, auch wenn das Gerät von seiner Betriebsspannung getrennt wird. Die Uhr läuft weiter, wird aber nicht angezeigt. Der Erhalt dieser Daten ist für ca. 1500 Stunden gewährleistet.

Beachten Sie bitte die Sicherheitshinweise für Lithiumbatterien auf Seite 5.



Notes for the Satellit 700

Power Supply

Battery or Accumulator Operation

With 4 "HP2" batteries IEC LR 20 (alkaline-manganese batteries) or Ni Cd accumulators of same size (commercially available).

- Only use accumulators with the inscription 1,24 V and 4000 mAh.
- Insert the batteries or accumulators with correct polarity.
- Attention: For battery operation, the slider switch ACCU/BATT. (in the battery compartment) must be set to BATT. When batteries are inserted, never set the switch to ACCU or leave it in this position (indication ACCU). No responsibility can be accepted for damage due to wrong operation of charging unit.

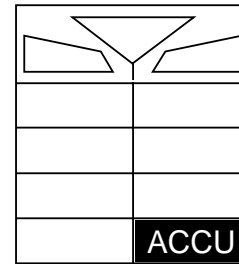

- When using Ni Cd accumulators, the switch must be set to ACCU (Indication ACCU).

Charging Time

With the AC adapter NR90, a charging time of up to 4 days will be required, depending on the charging state of the accumulators. Because of a inbuilt charging circuit the accumulators cannot be overloaded even nor if the AC adapter NR90 is permanently connected.

If the set cannot be switched on, or if the frequency indication only briefly flashes after switching on, then the supply voltage is too low. If this should be the case, replace the complete set of batteries or recharge the accumulators.

- Always remove exhausted batteries immediately!
- If the set is not in use for longer periods, remove batteries even if they are new!

No responsibility can be accepted for damage due to leaking batteries.

RESET Button

If, due to external interferences (caused by static charges of carpets, thunderstorms, etc.), the control electronic of the Satellit 700 should receive wrong information signals, or if no entries at all are possible, then press the RESET button in the MEMOFILE box by a pointed object. By that the unit is reset to its basic programming values. The contents of the individual station memory positions are not affected.

Data Protection

When the set is switched off, a built-in standby battery (lithium battery, which is automatically recharged when the unit is ready for operation) protects all memories, also when no power supply is connected. The clock continues running, but the time is not displayed. Storage of data is guaranteed for a duration of 1500 hours. Observe the safety requirements for lithium batteries on page 5.

Automatische Steuerung eines Cassettengerätes

Der Satellit 700 kann ein Cassettengerät mit positiver bzw. negativer Steuerlogik bei Schaltuhr-Betrieb automatisch starten bzw. stoppen. Dazu muß ein entsprechendes Steuerkabel angefertigt werden. Die Schaltstufe zur Steuerung des Cassettengerätes arbeitet potentialfrei. Die vom Cassettengerät zugeführte Schaltspannung (max. 30V/500mA) wird an der Schaltausgangsbuchse wie folgt beeinflusst:

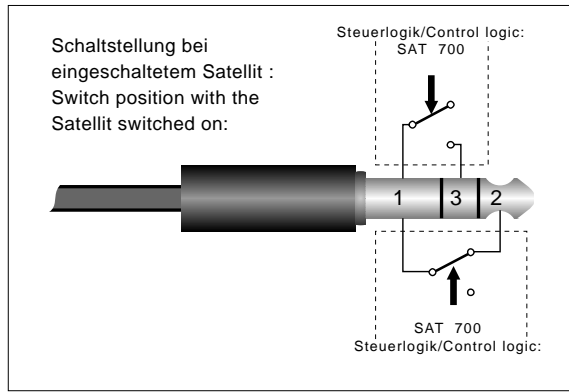

Automatic Control of a Cassette Recorder

With the Satellit 700 it is possible to automatically start and stop a cassette recorder which is equipped with a positive or negative control logic circuit. For this, a special connecting lead must be built. The switching circuit for controlling the cassette recorder operates potential-free. The switching voltage delivered by the cassette recorder (max. 30V/500mA) is changed by the switch jack as follows.

Befestigen des Gerätes

Der Satellit 700 läßt sich festschrauben. Hierzu sind im Boden zwei Gewindelöcher M4. Verwenden Sie Schrauben, die mindestens 15mm und maximal 19mm länger sind, als die Materialstärke der Montageebene.

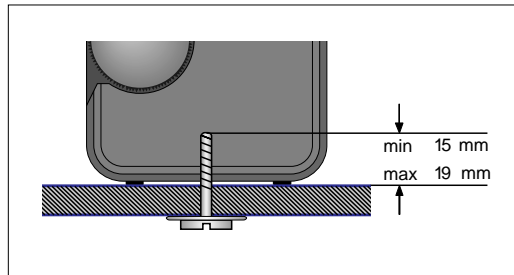

Securing the Unit

The Satellit 700 can be secured to an appropriate surface. For this, two threaded holes M4 are provided in its base. Only use screws which are at least 15mm and max. 19mm longer than the thickness of the material to which the Satellit is to be secured.

Memofiles

Sie haben die Möglichkeit beim Satellit 700 durch zusätzliche MEMOFILES (ICs) die Speicherkapazität um 3x 512 Speicherplätze zu erweitern. Die Einsteckplätze für 3 MEMOFILES befinden sich hinter der Klappe unterhalb des Bedienfeldes.

Es ist darauf zu achten, daß das MEMOFILE-IC polungsrichtig eingesetzt wird. Drücken Sie das MEMOFILE vorsichtig in den jeweiligen IC-Sockel. Beachten Sie auch die Nummerierung der IC-Sockel. Dies ist für den MEMOFILE-Aufruf wichtig. Bezeichnung der MEMOFILES: X24C16-P3
Sachnummer: 8305-602-416

Memofiles

You have the possibility to increase the memory capacity of your Satellit 700 by 3x512 memory positions with additionally MEMOFILES (ICs). The sockets for inserting 3 MEMOFILES are to be found behind the trap below the keyboard.

Ensure that the MEMOFILE IC be inserted with correct polarity. Carefully press the MEMOFILE IC into the respective socket. When doing this, also observe the numbering of the IC sockets. This is of importance when later "calling up" the respective MEMOFILE. Name of the MEMOFILES: X24C16-P3
Order No.:8305-602-416

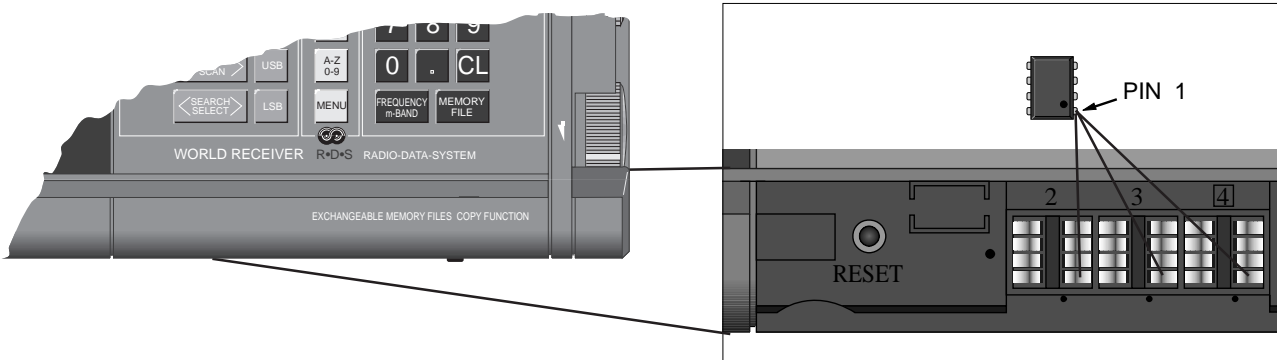

Lautsprecher-Buchse

Kontaktbelegung des Steckers für zwei Außenlautsprecher.

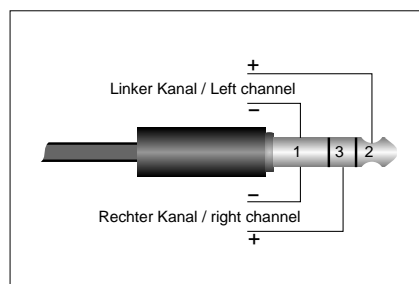

Loudspeaker Socket

Contact allocation of the plug for two external loudspeakers.

Synchrondetektor

Reicht die Bandbreiteneinstellung "schmal" nicht aus, um zwei unmittelbar nebeneinander liegende Sender ausreichend zu trennen, so können Sie mit der Synch-Funktion den Empfang optimieren. Sie können wahlweise auf unteres oder oberes Seitenband abstimmen. Einzelheiten entnehmen Sie bitte der Bedienungsanleitung (Sachnummer 15055-941.01).

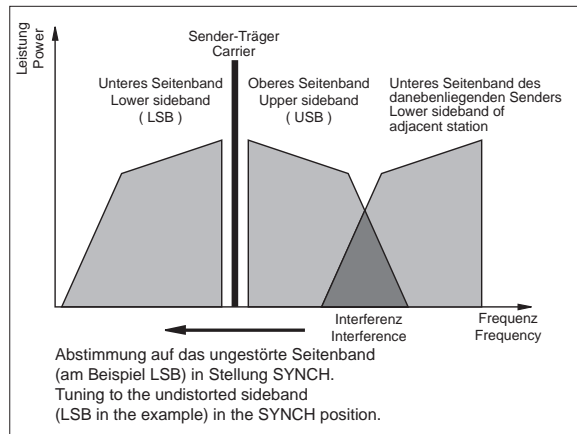

Synchronous Demodulator

If the "narrow" bandwidth setting does not suffice to separate two closely adjacent stations, there still remains the possibility to optimize station tuning by means of the synchronous demodulator. You alternatively can tune to the lower or upper sideband. For details see the instruction manual (Order No. 15055-941.01).

RDS-Testmode

Im RDS-Testmode können PI-Code und TP/TA-Schaltzustand, PS-Namen, PTY-Code und M/S-Schaltzustand, benachbarte AFs sowie die RDS-Fehlerrate angezeigt werden.

The RDS Test Mode

In RDS Test Mode it is possible to indicate the PI code and the TP/TA flags, the PS name, PTY code and the M/S flag, the next and previous AFs and the RDS error rate.

Einschalten des Testmodes:

Gerät auf FM schalten und die Taste SYNCH länger als 3 Sekunden gedrückt halten.

Switching the Test Mode on

To start the Test Mode, select the FM band and press the SYNCH button for more than 3 seconds.

Beim Eintritt in den Testmode werden zuerst der PI-Code und die TP/TA-Schaltzustände im Display angezeigt (TP-Code: TP=Sender; 1=ja; 0=nein). Diese Anzeige kann aus den anderen Testfunktionen durch kurzes Drücken der Taste SYNCH erreicht werden.



When entering the Test Mode, at first PI code and TP/TA flags are shown on the display (TP code: TP broadcast station; 1 = yes; 0 = no).

This indication can be made to appear in all test functions by shortly pressing the SYNCH button

RDS-Qualität:

Die im Normalbetrieb mit der Taste abrufbare RDS-Qualitätsanzeige (Bargraph) ist im Testmode ständig aktiv. Die Barcode-Anzeige wird aus den letzten 16 empfangenen RDS-Blöcken (gleitender Mittelwert) gebildet. Hier kann die Beeinträchtigung der RDS-Qualität durch die Modulation und/oder durch die Antennenausrichtung sehr gut beobachtet werden.

RDS Quality

The RDS quality, which is normally displayed (bar graph) by pressing the button , is permanently shown when the Test Mode is active. The displayed bar code is built up by the last 16 of the received RDS blocks (sliding average). In this case, the impairment of the RDS quality by modulation and/or adjustment of the antenna can be observed very well.

RDS-Alternativfrequenzen:

Durch Betätigung der Taste LSB (kurz: nächste AF; lang: vorhergehende AF) werden die RDS-AFs nacheinander eingestellt. Es erfolgt keine Überprüfung der AFs auf Sendermitte, Feldstärke und PI-Code! Daher können alle seit der letzten RDS-Blocksynchrisation empfangenen AFs eingestellt werden, auch wenn diese am Empfangsort zu einem anderen Programm gehören.

RDS Alternative Frequencies (AF)

By pressing the LSB button (short: next AF; long: previous AF), the RDS-AFs are tuned in one after another. There is no test for the center frequency, field strength and PI code. Therefore, all AFs received since the last RDS block synchronisation can be tuned in even if they belong at the actual reception area to another programme.

PS-Name

Durch einmalige Betätigung der Taste USB wird der Name des RDS-Senders angezeigt. Wird der Sender nun neu eingestellt, kann in der Anzeige der Aufbau des Schriftzuges beobachtet werden. Im Normalbetrieb wird der Schriftzug erst angezeigt, wenn der Name vollständig empfangen wurde.

PS Name

By pressing the USB button once, the name of the RDS station is displayed. After calling up a station the setup of the name can be observed in the display. In normal mode, the name is displayed only if it was received completely.

PTY-Code

Bei nochmaliger Betätigung der Taste USB wird der PTY-Code (dezimal; 00=nicht benützt) und der M/S-Schaltzustand (M=Musik; S=Sprache) angezeigt.



PTY Code

After pressing the USB button a second time the PTY code (decimal; 00 = not used) and the M/S flag (M = Music, S = Speech) are displayed.

RDS-Fehlerrate

Durch Drücken der Taste werden die momentane und die maximale RDS-Fehlerrate seit der letzten RDS-Blocksynchrisation angezeigt. Gemessen werden jeweils 100 Blöcke (=2s).



RDS Error Rate

Pressing the button shows the momentary and maximum error rates since the last RDS block synchronisation. In each case 100 blocks (= 2s) are used for measurement.

Werden in einer Test-Funktion nur _ _ angezeigt, sind keine RDS-Signale dekodierbar.

Displaying _ _ in any test function means that no RDS signals can be decoded.

Der Testmode wird durch Drücken der Taste >3s oder durch Ausschalten des Gerätes beendet.

The Test Mode is terminated by pressing the button for more than 3s or by switching the receiver off.

Testmode

Aktivieren des Testmodes

- Gerät ausschalten.
- Eingabe des Testcodes 050251.
- Drücken der Taste STORE.

Taste AUTO:
Anzeige aller Segmente
COMMON 1 des Displaytrei-
bers 1

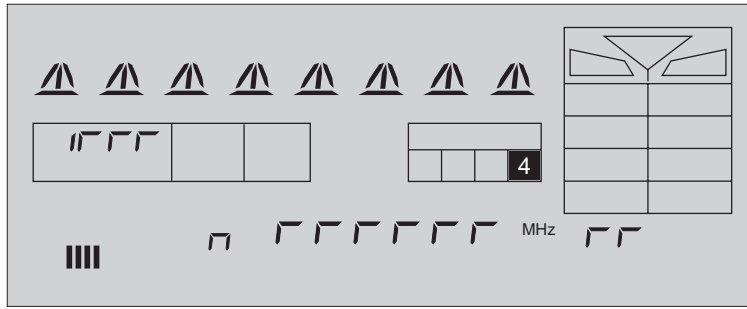

Button AUTO:
All segments of COMMON 1
of the display driver 1 lights
up.

Taste SLEEP:
Anzeige aller Segmente
COMMON 2 des Displaytrei-
bers 1

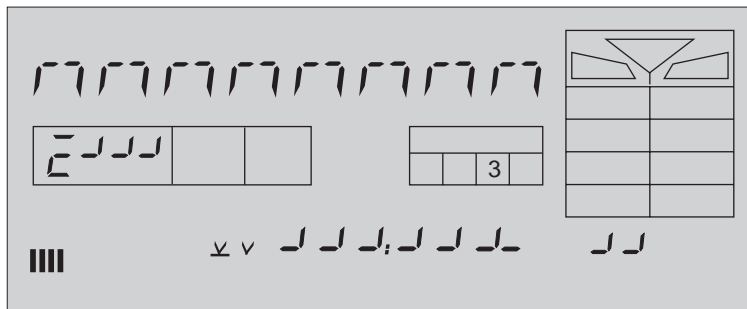

Button SLEEP:
All segments of COMMON 2
of the display driver 1 lights
up.

Taste TIME I/II:
Anzeige aller Segmente
COMMON 1 des Displaytrei-
bers 2

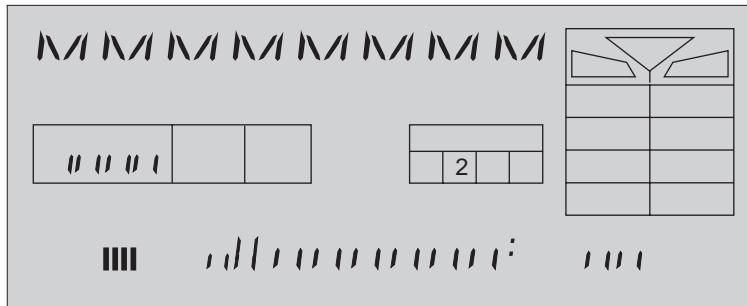

Button TIME I/II:
All segments of COMMON 1
of the display driver 2 lights
up.

Taste A-Z:
Anzeige aller Segmente
COMMON 2 des Displaytrei-
bers 2

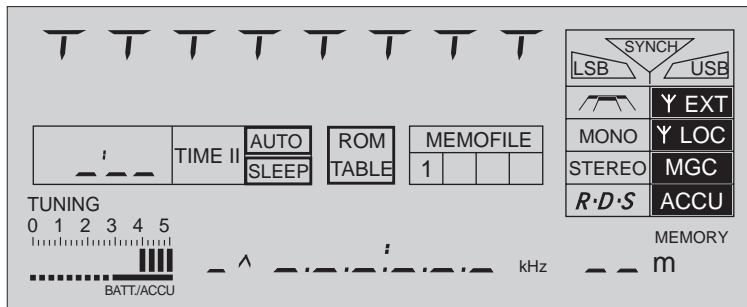

Button A-Z:
All segments of COMMON 2
of the display driver 2 lights
up.

Taste MENU:
Anzeige aller Segmente

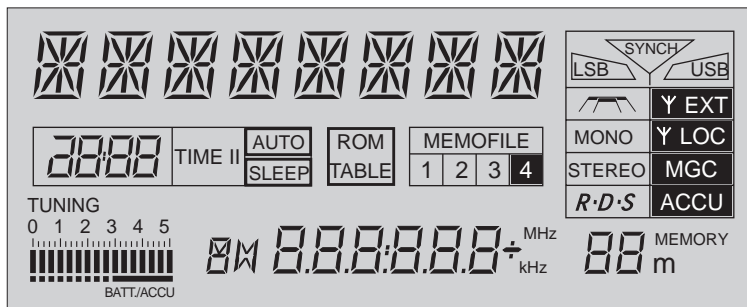

Button MENU:
All segments lights up.

Beenden des Testmodes

Der Testmode endet automatisch mit dem Ausschalten des Gerätes.

Finishing the testmode

The testmode finishes automatically when switching off the unit.

Laufschrift im Display

Ein- und Ausschalten der Laufschrift: 1 2 3 4 5 6 eingeben und Gerät einschalten.

Running letters in the display

Switching on and off the running letters: Feed in 1 2 3 4 5 6 and press the ON/OFF button.

Abgleich

Bei Batteriespannung $U_b = 6 \text{ V}$.

Bedieneinheit

Uhrfrequenz

Voreinstellungen: keine
Einspeisung: keine
Messung: Frequenzzähler mit Tastkopf lose an Meßpunkt ⑫ .
Abgleich: Mit C 1128 ⑲ 32,768 kHz $\pm 0,1 \text{ Hz}$

PWM-Arbeitspunkt

Voreinstellungen: SW; 30 MHz
Einspeisung: keine
Messung: Voltmeter an Meßpunkt ⑳ .
Abgleich: Mit R 1135 ㉑ 25 V -2 V/+ 0V

HF-Platte

Bei Geräten in Italien Version muß die Diode D11 eingelötet werden.

6,275 MHz-Referenz

Voreinstellungen: keine
Einspeisung: keine
Messung: Frequenzzähler mit Tastkopf lose an Meßpunkt ⑬ .
Abgleich: Mit C 138 ㉒ 6,275 MHz $\pm 50 \text{ Hz}$ einstellen

54,05 MHz-Referenz

Voreinstellungen: keine
Einspeisung: keine
Messung: Frequenzzähler mit Tastkopf lose an Meßpunkt ⑭ .
Abgleich: Mit C 154 ㉓ 54,05 MHz $\pm 100 \text{ Hz}$ einstellen

VCO 2

Voreinstellungen: LW; 150 kHz
Einspeisung: keine
Messung: Voltmeter an Meßpunkt ④ .
Abgleich: Mit C 217 ④ 25 V $\pm 150 \text{ mV}$ einstellen.

VCO 1

Voreinstellungen: LW; 150 kHz / SW; 30 MHz
Einspeisung: keine
Messung: Voltmeter an Meßpunkt ⑳ .
Abgleich: Mit L 411 ㉔ bei 150 kHz 3,5 V $\pm 50 \text{ mV}$ einstellen.
Mit C 403 ㉕ bei 30 MHz 17 V $\pm 100 \text{ mV}$ einstellen.
Abgleich wechselseitig wiederholen.

3,6 MHz (Grobabgleich)

Voreinstellungen: SW / USB; Clarify-Regler Mittelstellung
Einspeisung: keine
Messung: Voltmeter an Meßpunkt ⑥ .
Abgleich: Mit R 812 ⑥ 1,65 V $\pm 50 \text{ mV}$ einstellen.

AM-ZF 2 und 1

ZF 2:
Voreinstellungen: MW; 1612 kHz; Bandbreite schmal; Kern der Spule L 502 ㉖ bündig mit Becheroberkante voreinstellen;
Einspeisung: Wobbler 450 kHz an Meßpunkt ⑨ .
Messung: Oszilloskop an Meßpunkt ⑧ .
Abgleich: Mit L 409 ㉗ und L 501 ㉘ auf Maximum und Symmetrie, danach mit L 502 ㉖ auf Maximum einstellen.
ZF 1:
Voreinstellungen: MW; 1612 kHz; Bandbreite schmal; F5 ⑩A nach innen verstimmen;
Einspeisung: Wobbler 1612 kHz/400 Hz/ 30% an Meßpunkt ⑩ .
Messung: Oszilloskop an Meßpunkt ⑧ .
Abgleich: Mit F7 ⑩B auf Mitte, danach mit F5 ⑩A auf Symmetrie einstellen.
F7 ⑩B mit Sendersignal 1612 kHz/400 Hz/ 30% abschließend auf NF-Maximum an Meßpunkt ⑰ oder ⑱ abgleichen.

Alignment

At batterie voltage $U_b = 6 \text{ V}$.

Operating Unit

Clock frequency

Presettings: none
Feeding: none
Measuring: Frequency counter with probe loosely to testpoint ⑫ .
Alignment: Adjust C 1128 ⑲ to 32,768 kHz $\pm 0,1 \text{ Hz}$

PWM Operating point

Presettings: SW; 30 MHz
Feeding: none
Measuring: Voltmeter to testpoint ⑳ .
Alignment: Adjust R 1135 ㉑ to 25 V -2 V/+ 0V

RF-Board

At units in Italian version diode D11 must be soldered in.

6,275 MHz Reference

Presettings: none
Feeding: none
Measuring: Frequency counter with probe to testpoint ⑬ .
Alignment: Adjust C 138 ㉒ to 6,275 MHz $\pm 50 \text{ Hz}$

54,05 MHz-Reference

Presettings: none
Feeding: none
Measuring: Frequency counter with probe loosely to testpoint ⑭ .
Alignment: Adjust C 154 ㉓ to 54,05 MHz $\pm 100 \text{ Hz}$

VCO 2

Presettings: LW; 150 kHz
Feeding: none
Measuring: Voltmeter to testpoint ④ .
Alignment: Adjust C 217 ④ to 25 V $\pm 150 \text{ mV}$.

VCO 1

Presettings: LW; 150 kHz / SW; 30 MHz
Feeding: none
Measuring: Voltmeter to testpoint ⑳ .
Alignment: Adjust L 411 ㉔ at 150 kHz to 3,5 V $\pm 50 \text{ mV}$.
Adjust C 403 ㉕ at 30 MHz to 17 V $\pm 100 \text{ mV}$.
Repeat the adjustment reciprocally.

3,6 MHz (coarse adjustment)

Presettings: SW / USB; Clarify control to middle position
Feeding: none
Measuring: Voltmeter to testpoint ⑥ .
Alignment: Adjust R 812 ⑥ to 1,65 V $\pm 50 \text{ mV}$.

AM-IF 2 and 1

IF 2:
Presettings: MW; 1612 kHz; bandwidth narrow; Preadjust the core of the coil L 502 ㉖ flushly with the upper end of the bobbin;
Feeding: Sweep generator 450 kHz to testpoint ⑨ .
Measuring: Oscilloscope to testpoint ⑧ .
Alignment: Adjust L 409 ㉗ and L 501 ㉘ to maximum and symmetry, than L 502 ㉖ to maximum.
IF 1:
Presettings: MW; 1612 kHz; bandwidth narrow; detune F5 ⑩A to the inner;
Feeding: Sweep generator 1612 kHz/400 Hz/ 30% to testpoint ⑩ .
Measuring: Oscilloscope to testpoint ⑧ .
Alignment: Adjust F7 ⑩B to center, than F5 ⑩A to symmetry.
Finally adjust F7 ⑩B with test signal 1612 kHz/400 Hz/ 30% to AF maximum at testpoint ⑰ or ⑱ .

SW-Vorkreise

Voreinstellungen: SW; Antennenschalter auf INT;
Empfindlichkeitsschalter auf DX; Teleskopantenne ablöten.
Einspeisung: Wobbler über 15 pF an Meßpunkt ⑩ .
Messung: Oszilloskop an Meßpunkt ⑩ .
Abgleich: Jeweils auf Maximum abgleichen:

Frequenz	Abgleichpunkt
SW1-1612 kHz	L 212 ①A und L 213 ①B .
SW1-4095 kHz	C 224 ①C und C 226 ①D .
SW2-4096 kHz	L 214 ①E und L 215 ①F .
SW2-8191 kHz	C 231 ①G und C 223 ①H .
SW3-8192 kHz	L 216 ①J und L 217 ①K .
SW3-20479 kHz	C 237 ①I und C 241 ①M .
SW4-20480 kHz	L 218 ①N und L 219 ①O .
SW4-30000 kHz	C 243 ①P und C 246 ①Q .

3,6 MHz (Feinabgleich)

Voreinstellungen: SW/USB; Antennenschalter auf EXT
Einspeisung: Meßsender an Antennenbuchse.
22200 kHz unmoduliert
Messung: keine
Abgleich: Mit C 818 ⑥B auf Schwebungsnull abgleichen.

MW/LW-Vorkreise

Voreinstellungen: MW/LW
Einspeisung: Sendersignal über Rahmen einblasen;
Modulation 400 Hz / 30 %
Messung: Oszilloskop an Meßpunkt ⑰ oder ⑱ .
Abgleich: Jeweils auf Maximum abgleichen:

Frequenz	Abgleichpunkt
MW 528 kHz	L 209 ⑫A
MW 1611 kHz	C 209 ⑫B
LW 150 kHz	L 208 ⑫C
LW 353 kHz	C 213 ⑫D

Bei Geräten in Italien-Version muß die Diode D11 wieder entfernt werden.

FM-Oszillator

Voreinstellungen: FM 87,5 MHz/108 MHz
Einspeisung: keine
Messung: Voltmeter an Meßpunkt ① .
Abgleich: Mit L 308 ⑤ bei 87,5 MHz 2,5 V \pm 50 mV einstellen.
Mit C 324 ⑥ bei 108 MHz 25 V \pm 100 mV einstellen.
Abgleich wechselseitig wiederholen.

FM-ZF

Voreinstellungen: FM 93 MHz; Antennenschalter auf EXT.
Einspeisung: Wobbler an Antennenbuchse.
Messung: Oszilloskop an Meßpunkt ⑭ .
Abgleich: Mit F1 ⑭A auf Maximum und Symmetrie abgleichen.
Eventuell mit C 531 ⑳ Nulldurchgang der S-Kurve voreinstellen.

FM-Vor- und Zwischenkreise

Voreinstellungen: FM; Antennenschalter auf EXT.
Einspeisung: Meßsender an Antennenbuchse; FM, $f_{\text{mod}} = 1$ kHz, $\Delta f = 22,5$ kHz;
Messung: Oszilloskop an Meßpunkt ⑰ oder ⑱ .
Abgleich: Mit L 302 ①A bei 88 MHz Maximum einstellen.
Mit C 304 ② bei 106 MHz Maximum einstellen.
Abgleich wechselseitig wiederholen.
Mit L 304 ③ und L 305 ④ bei 95 MHz Maximum einstellen.
Abgleich wechselseitig wiederholen.

Klirrfaktor

Voreinstellungen: FM; Antennenschalter auf EXT.
Einspeisung: Meßsender an Antennenbuchse;
FM, $f_{\text{mod}} = 1$ kHz, 1 mV, $\Delta f = 22,5$ kHz;
Messung: Klirrfaktormessgerät an Meßpunkt ⑮ .
Abgleich: Mit L 504 ⑮ bei 95 MHz Minimum einstellen.

SW-RF circuit

Presettings: SW; Aerial switch to INT; Distant/Local switch to DX;
unsolder the telescopic aerial.
Feeding: Sweep generator with 15 pF to testpoint ⑪ .
Measuring: Oscilloscope to testpoint ⑪ .
Alignment: Adjust all to maximum:

Frequency	Alignment point
SW1-1612 kHz	L 212 ①A and L 213 ①B .
SW1-4095 kHz	C 224 ①C and C 226 ①D .
SW2-4096 kHz	L 214 ①E and L 215 ①F .
SW2-8191 kHz	C 231 ①G and C 223 ①H .
SW3-8192 kHz	L 216 ①J and L 217 ①K .
SW3-20479 kHz	C 237 ①I and C 241 ①M .
SW4-20480 kHz	L 218 ①N and L 219 ①O .
SW4-30000 kHz	C 243 ①P and C 246 ①Q .

3,6 MHz (fine adjustment)

Presettings: SW/USB; Aerial switch to EXT
Feeding: Test generator to aerial sockt.
22200 kHz unmodulated
Measuring: none
Alignment: Adjust C 818 ⑥B to zero beat.

MW/LW-RF circuit

Presettings: MW/LW
Feeding: Feed in the generator signal with a frame aerial;
Modulation 400 Hz / 30 %
Measuring: Oscilloscope to testpoint ⑰ or ⑱ .
Alignment: Adjust all to maximum:

Frequency	Alignment point
MW 528 kHz	L 209 ⑫A
MW 1611 kHz	C 209 ⑫B
LW 150 kHz	L 208 ⑫C
LW 353 kHz	C 213 ⑫D

At units in Italian version the diode D11 must be removed again.

FM-Oscillator

Presettings: FM 87,5 MHz/108 MHz
Feeding: none
Measuring: Voltmeter to testpoint ① .
Alignment: Adjust L 308 ⑤ to 2,5 V \pm 50 mV at 87,5 MHz.
Adjust C 324 ⑥ to 25 V \pm 100 mV at 108 MHz.
Repeat the adjustment reciprocally.

FM-IF

Presettings: FM 93 MHz; Aerial switch to EXT.
Feeding: Sweep generator to aerial socket.
Measuring: Oscilloscope to testpoint ⑭ .
Alignment: Adjust F1 ⑭A to maximum and symmetry.
Eventually preadjust the zero cross of the S-curve with C 531 ⑳ .

FM-Vor- und Zwischenkreise

Presettings: FM; Aerial switch to EXT.
Feeding: Test generator to aerial socket; FM, $f_{\text{mod}} = 1$ kHz, $\Delta f = 22,5$ kHz;
Measuring: Oscilloscop to testpoint ⑰ or ⑱ .
Alignment: Adjust L 302 ①A to maximum at 88 MHz .
Adjust C 304 ② to maximum at 106 MHz.
Repeat the adjustment reciprocally.
Adjust L 304 ③ and L 305 ④ to maximum at 95 MHz.
Repeat the adjustment reciprocally.

Distortion Factor

Presettings: FM; Aerial switch to EXT.
Feeding: Test generator to aerial socket;
FM, $f_{\text{mod}} = 1$ kHz, 1 mV, $\Delta f = 22,5$ kHz;
Measuring: Distortion factor meter to testpoint ⑮ .
Alignment: Adjust L 504 ⑮ to minimum at 95 MHz.

Suchlauf

Voreinstellungen: FM; Antennenschalter auf EXT.
 Einspeisung: Meßsender an Antennenbuchse;
 FM, 95 MHz, $f_{mod} = 50$ Hz, $100 \mu V$, $\Delta f = 50$ kHz;
 Oszilloskop; Y-Eingang an Meßpunkt ⑦.
 X-Extern, 50 Hz an X-Eingang
 Abgleich: Mit C 531 ②② den Rechteck-Impuls auf Frequenz-
 mitte einstellen.

RDS

Voreinstellungen: FM; Antennenschalter auf EXT; F 13 ②④ mit 10 nF
 überbrücken.
 Einspeisung: Meßsender an Antennenbuchse;
 FM; 95 MHz; 1 mV; RDS-Normsignal oder 57 kHz-
 fremdmoduliert, $\Delta f = 1,2$ kHz;
 Messung: NF-Voltmeter an Meßpunkt ⑤.
 Abgleich: Mit F12 ②③ Maximum einstellen.
 10 nF entfernen
 Mit F13 ②④ Minimum einstellen.

Feldstärkeanzeige

Voreinstellungen: SW; Antennenschalter auf INT; Teleskopantenne
 ablöten.
 Einspeisung: Meßsender an Meßpunkt ①.
 22200 kHz 150 μV unmoduliert
 Messung: keine
 Abgleich: Mit R 533 ①⑧ auf Tuning-Marke 4 (im Display)
 einstellen.

NF-Platte**Stereo 76 kHz-Oszillator**

Voreinstellungen: FM; Antennenschalter auf EXT.
 Einspeisung: Meßsender an Antennenbuchse;
 FM; 95 MHz; 1 mV; unmoduliert;
 Messung: Frequenzzähler lose an Meßpunkt ①⑥.
 Abgleich: Mit R 603 ①⑥ auf 76 kHz ± 100 Hz einstellen.

Stereo-Übersprechen

Voreinstellungen: FM; Antennenschalter auf EXT; 3,5 mm-Stereo-
 linkenstecker mit $2 \times 7,5 \Omega$ Abschlußwiderstand in
 Lautsprecherbuchse stecken.
 Einspeisung: Stereosender an Antennenbuchse;
 FM; 95 MHz; 1 mV; rechter Kanal moduliert;
 NF-Voltmeter über Tiefpaß an Meßpunkt ①⑦.
 Abgleich: Mit R 605 ①⑦ Minimum einstellen.
 Einspeisung: Stereosender an Antennenbuchse;
 FM; 95 MHz; 1 mV; linker Kanal moduliert;
 NF-Voltmeter über Tiefpaß an Meßpunkt ①⑧.
 Abgleich: Mit R 605 ①⑦ gegebenenfalls ausmitteln.

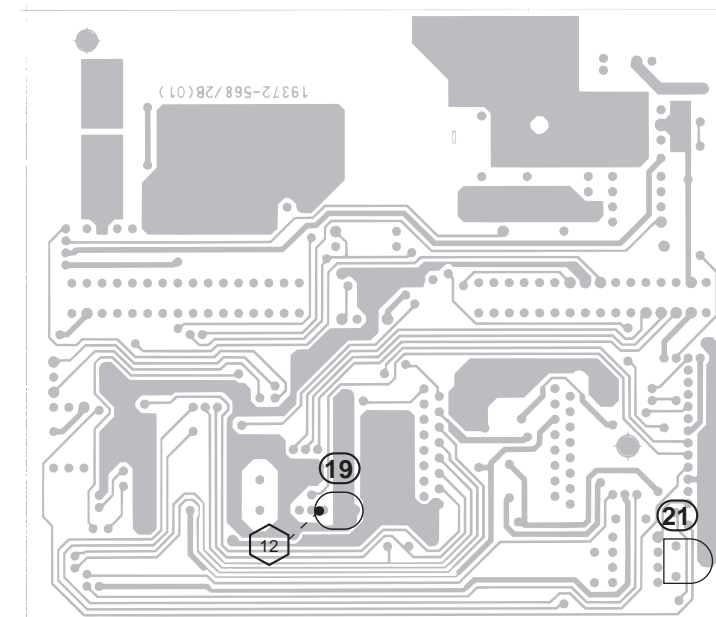
**Station search**

Presettings: FM; Aerial switch to EXT.
 Feeding: Test generator to aerial socket;
 FM, 95 MHz, $f_{mod} = 50$ Hz, $100 \mu V$, $\Delta f = 50$ kHz;
 Oscilloscope; Y-input to testpoint ⑦.
 X-Extern, 50 Hz into X-input
 Alignment: By using C 531 ②② adjust the square pulse to
 frequency middle.

RDS

Presettings: FM; Aerial switch to EXT; short circuit F 13 ②④ with
 a 10 nF capacitor.
 Feeding: Test generator to aerial socket;
 FM; 95 MHz; 1 mV; RDS standard signal or 57 kHz
 modulated externally, $\Delta f = 1,2$ kHz;
 Measuring: AF-Voltmeter to testpoint ⑤.
 Alignment: Adjust F12 ②③ to maximum.
 Remove the 10 nF capacitor
 Adjust minimum by F13 ②④.

Field strength indication

Presettings: SW; Aerial switch to INT; unsolder the telescopic
 aerial.
 Feeding: Test generator to testpoint ①.
 22200 kHz 150 μV unmodulated
 Measuring: none
 Alignment: By using R 533 ①⑧ adjust to tuning mark 4 (at
 Display).

AF-Board**Stereo 76 kHz Oscillator**

Presettings: FM; Aerial switch to EXT.
 Feeding: Test generator to aerial socket;
 FM; 95 MHz; 1 mV; unmodulated;
 Measuring: Frequency counter loosely to testpoint ①⑥.
 Alignment: By using R 603 ①⑥ adjust 76 kHz ± 100 Hz.

Stereo Crosstalk

Presettings: FM; Aerial switch to EXT; plug-in a 3,5 mm stereo
 jack plug with $2 \times 7,5 \Omega$ terminating impedance into
 the speaker socket.
 Feeding: Stereo generator to aerial socket;
 FM; 95 MHz; 1 mV; right channel modulated;
 Measuring: AF Voltmeter by a low-pass filter to testpoint ①⑦.
 Alignment: Adjust R 605 ①⑦ to minimum.
 Feeding: Stereo generator to aerial socket;
 FM; 95 MHz; 1 mV; left channel modulated;
 Measuring: AF Voltmeter by a low-pass filter to testpoint ①⑧.
 Alignment: If necessary adjust R 605 ①⑦ to the middle value.

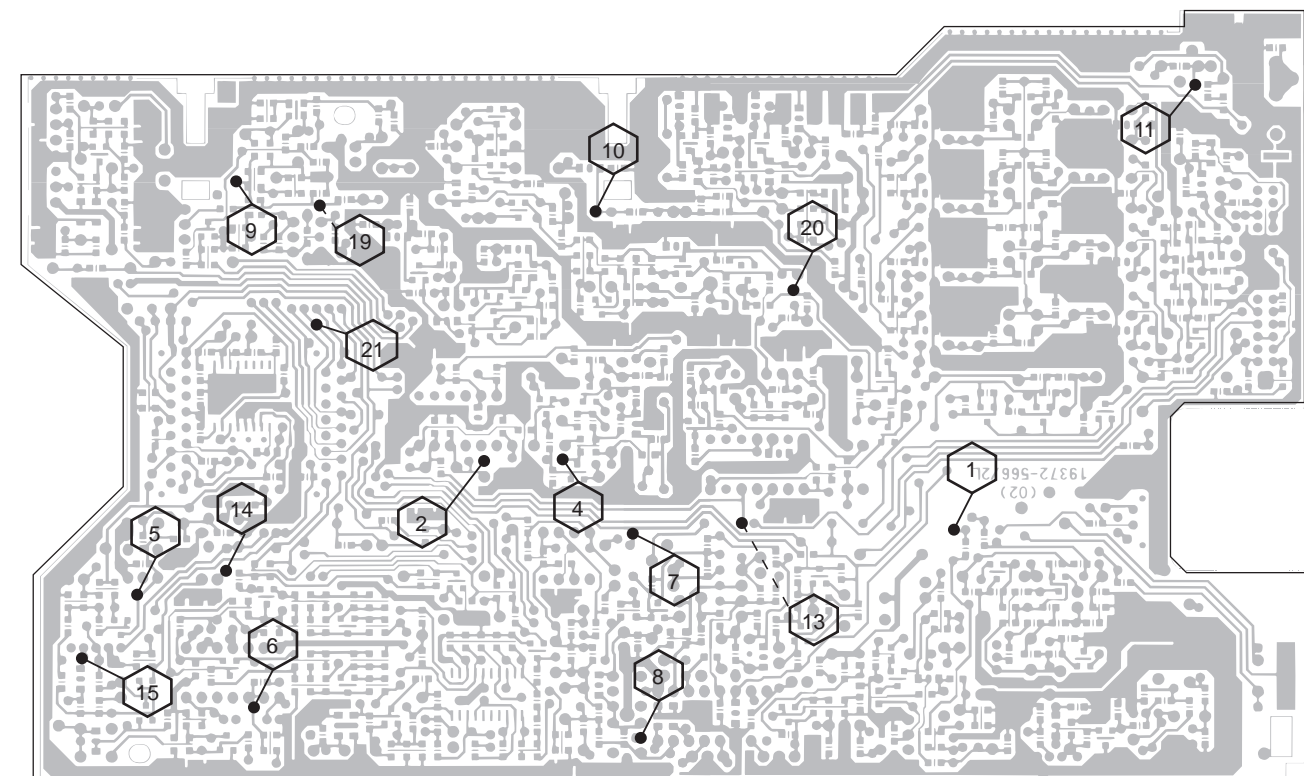
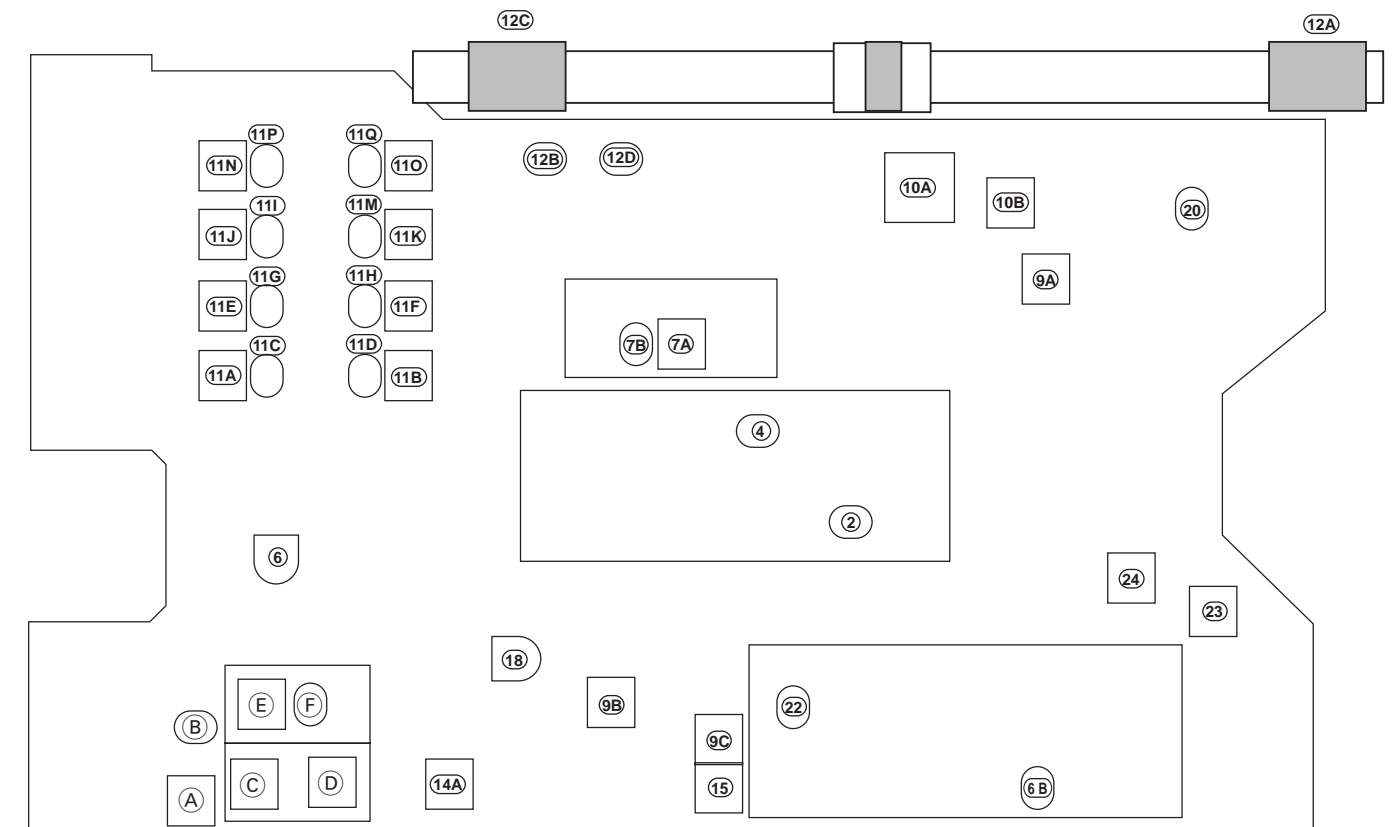
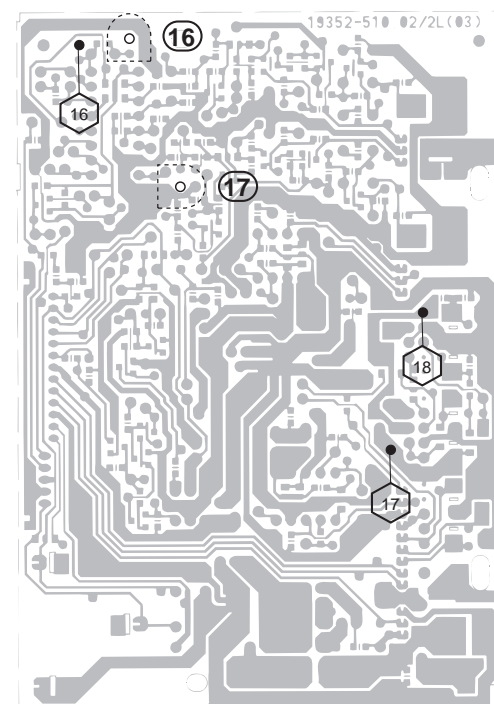

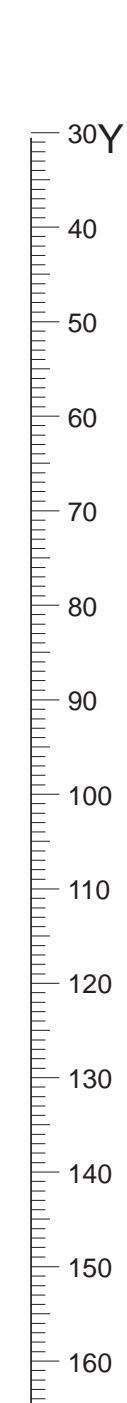
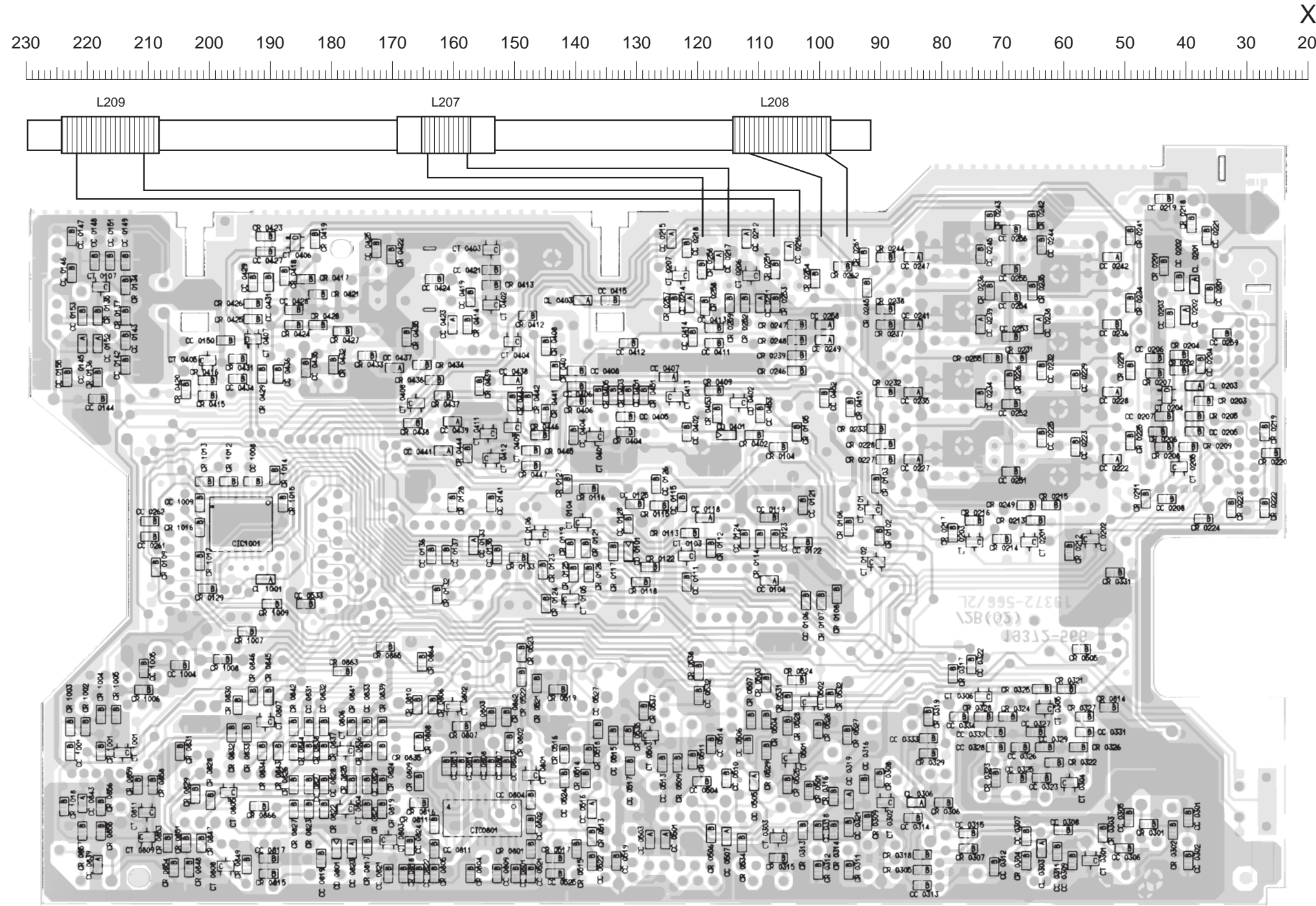

Bauteil	X	Y	Bauteil	X	Y	Bauteil	X	Y	Bauteil	X	Y	Bauteil	X	Y	Bauteil	X	Y	Bauteil	X	Y	Bauteil	X	Y						
CC 0104	109	111	CC 0152	219	73	CC 0234	74	82	CC 0311	62	156	CC 0413	118	70	CC 0510	116	144	CC 0823	177	155	CR 0102	91	104	CR 0135	219	68	CR 0228	90	89
CC 0106	103	115	CC 0153	221	68	CC 0235	85	81	CC 0312	72	158	CC 0414	121	72	CC 0513	126	141	CC 0824	168	155	CR 0103	91	96	CR 0136	219	78	CR 0229	50	77
CC 0111	122	112	CC 0155	224	78	CC 0236	83	70	CC 0313	84	161	CC 0415	135	66	CC 0514	118	138	CC 0827	184	145	CR 0104	107	90	CR 0137	214	68	CR 0231	68	75
CC 0115	123	99	CC 0156	214	58	CC 0238	65	70	CC 0314	85	150	CC 0419	158	65	CC 0515	134	137	CC 0828	182	145	CR 0105	104	87	CR 0201	44	60	CR 0232	90	81
CC 0118	119	101	CC 0201	37	65	CC 0239	74	70	CC 0315	76	153	CC 0421	154	61	CC 0516	138	149	CC 0829	175	145	CR 0106	96	103	CR 0202	42	77	CR 0233	91	87
CC 0119	109	101	CC 0202	42	63	CC 0241	85	70	CC 0316	93	145	CC 0423	161	70	CC 0517	131	142	CC 0831	184	135	CR 0107	100	115	CR 0203	38	82	CR 0234	50	66
CC 0121	103	99	CC 0203	43	69	CC 0242	53	59	CC 0318	101	152	CC 0424	164	62	CC 0519	134	157	CC 0832	182	135	CR 0108	98	114	CR 0204	42	75	CR 0235	66	64
CC 0122	103	105	CC 0204	38	76	CC 0244	64	57	CC 0319	96	147	CC 0425	173	57	CC 0521	148	159	CC 0833	175	135	CR 0109	209	109	CR 0205	39	85	CR 0236	73	64
CC 0123	108	105	CC 0205	39	87	CC 0245	74	58	CC 0321	96	152	CC 0427	191	58	CC 0522	138	157	CC 0839	219	158	CR 0112	118	106	CR 0206	45	87	CR 0237	90	70
CC 0124	113	105	CC 0206	46	75	CC 0247	85	59	CC 0322	76	125	CC 0428	187	67	CC 0524	142	144	CC 0843	221	148	CR 0113	122	104	CR 0207	46	78	CR 0238	90	67
CC 0125	131	99	CC 0207	44	85	CC 0249	100	72	CC 0323	64	144	CC 0429	193	63	CC 0525	144	159	CC 0001	223	139	CR 0114	110	105	CR 0208	44	90	CR 0239	104	75
CC 0126	127	96	CC 0208	44	98	CC 0251	69	94	CC 0325	68	144	CC 0431	191	63	CC 0527	137	136	CC 0004	205	125	CR 0115	127	99	CR 0209	40	90	CR 0241	50	55
CC 0128	132	102	CC 0211	110	66	CC 0252	69	83	CC 0326	68	139	CC 0434	196	78	CC 0532	120	130	CR 0116	138	96	CR 0211	47	98	CR 0242	66	53			
CC 0133	157	106	CC 0212	112	56	CC 0253	69	72	CC 0327	65	136	CC 0435	185	77	CC 0533	185	115	CR 0117	134	107	CR 0212	60	107	CR 0243	73	53			
CC 0135	153	107	CC 0214	122	66	CC 0254	69	65	CC 0328	72	139	CC 0436	189	78	CC 0801	150	159	CR 0118	130	112	CR 0213	65	102	CR 0244	90	59			
CC 0136	164	107	CC 0215	125	56	CC 0255	69	61	CC 0329	64	139	CC 0437	170	77	CC 0802	148	151	CR 0119	141	106	CR 0214	71	105	CR 0245	93	64			
CC 0137	162	107	CC 0216	105	58	CC 0256	69	54	CC 0331	57	136	CC 0438	151	79	CC 0803	152	142	CR 0121	139	106	CR 0215	63	99	CR 0246	104	77			
CC 0141	154	99	CC 0217	117	59	CC 0258	100	70	CC 0332	72	136	CC 0439	161	85	CC 0804	148	147	CR 0122	128	109	CR 0216	75	102	CR 0247	104	70			
CC 0142	214	76	CC 0218	122	57	CC 0259	35	71	CC 0333	83	137	CC 0441	162	90	CC 0807	154	142	CR 0123	146	110	CR 0217	79	104	CR 0248	104	72			
CC 0143	214	72	CC 0219	44	49	CC 0261	210	104	CC 0334	78	134	CC 0442	162	90	CC 0808	157	142	CR 0124	145	115	CR 0218	40	53	CR 0249	67	99			
CC 0144	219	82	CC 0221	37	55	CC 0262	210	102	CC 0402	122	87	CC 0452	100	82	CC 0809	153	159	CR 0125	141	110	CR 0219	28	87	CR 0251	108	61			
CC 0145	221	73	CC 0222	53	92	CC 0301	40	150	CC 0404	141	88	CC 0453	110	84	CC 0811	164	155	CR 0126	138	110	CR 0220	27	91	CR 0252	113	66			
CC 0146	223	61	CC 0223	59	90	CC 0302	40	157	CC 0405	132	85	CC 0501	126	154	CC 0813	162	142	CR 0127	142	96	CR 0222	28	100	CR 0253	108	66			
CC 0147	223	55	CC 0225	64	88	CC 0305	50	150	CC 0406	140	80	CC 0503	128	154	CC 0814	159	142	CR 0128	161	99	CR 0223	33	100	CR 0254	101	62			
CC 0148	220	59	CC 0227	85	92	CC 0306	51	155	CC 0407	125	78	CC 0504	120	144	CC 0817	191	157	CR 0129	201	113	CR 0224	38	101	CR 0255	72	75			
CC 0149	216	59	CC 0228	53	81	CC 0307	67	153	CC 0408	140	77	CC 0505	111	144	CC 0819	182	157	CR 0132	163	114	CR 0225	50	89	CR 0256	120	61			
CC 0150	198	72	CC 0229	59	79	CC 0308	61	152	CC 0411	118	73	CC 0506	112	138	CC 0821	171	159	CR 0133	150	108	CR 0226	69	79	CR 0257	124	66			
CC 0151	218	59	CC 0232	64	77	CC 0309	59	157	CC 0412	132	73	CC 0507	116	153	CC 0822	166	159	CR 0134	214	63	R 0227	90	92	CR 0258	119	67			

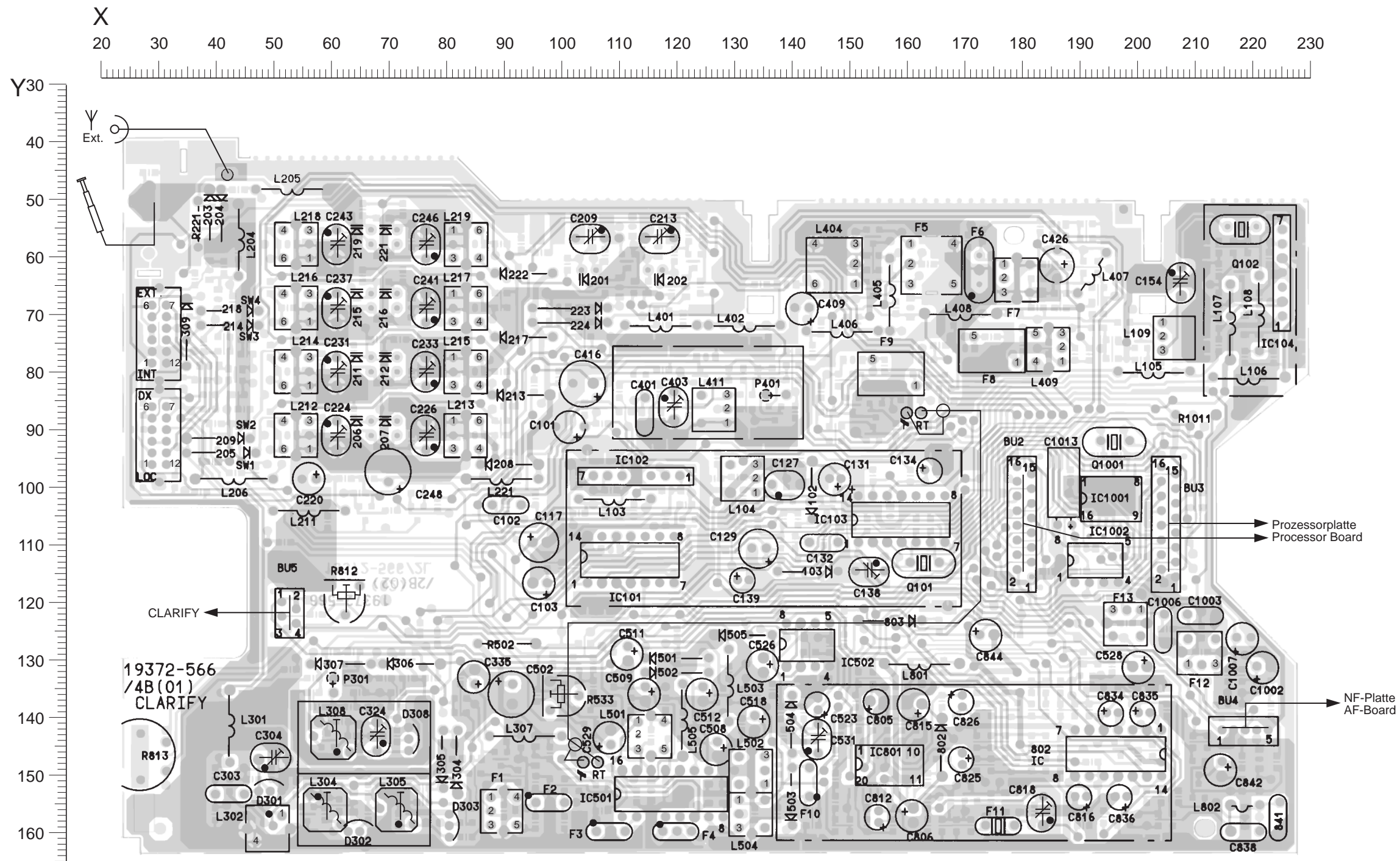

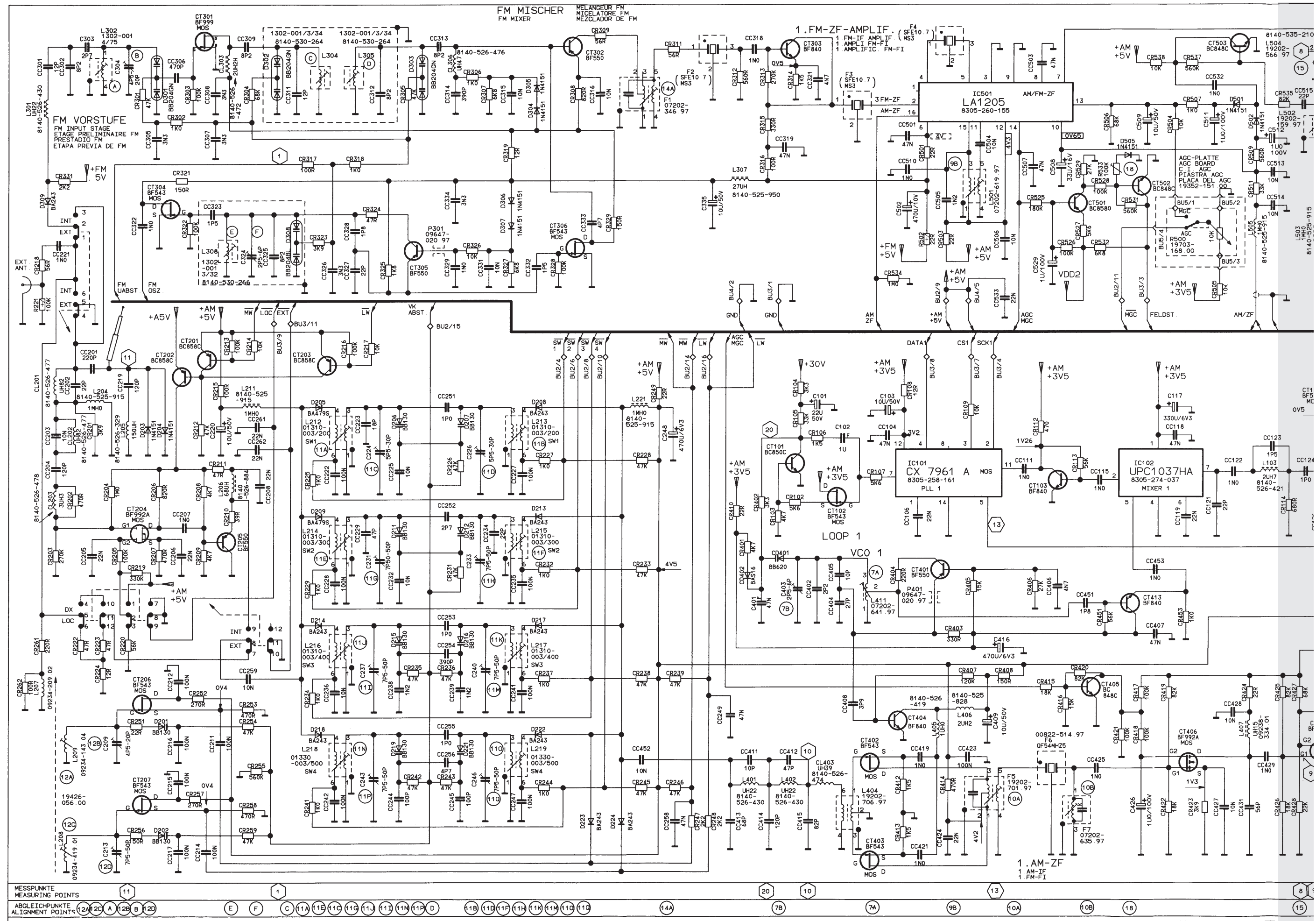

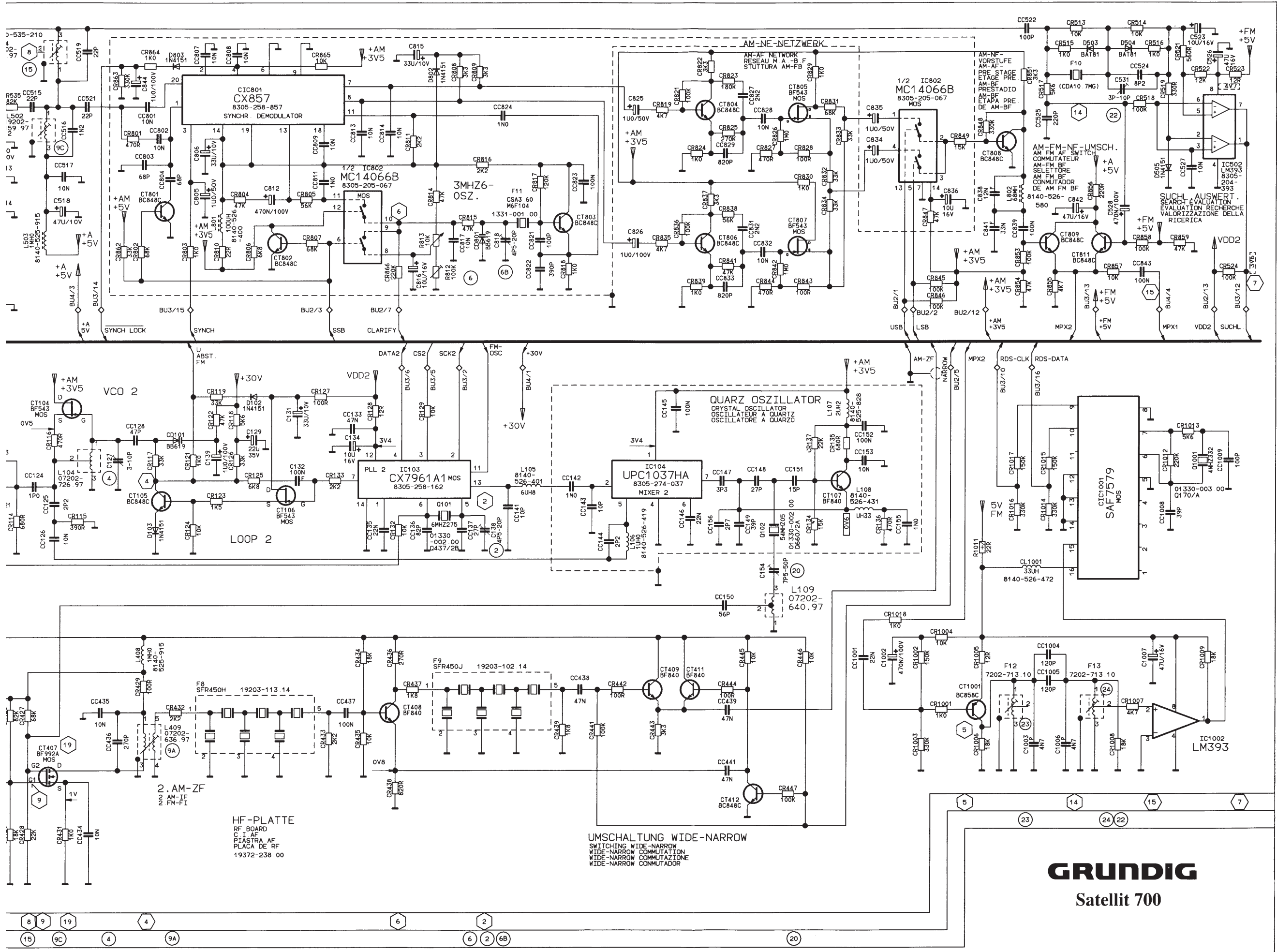

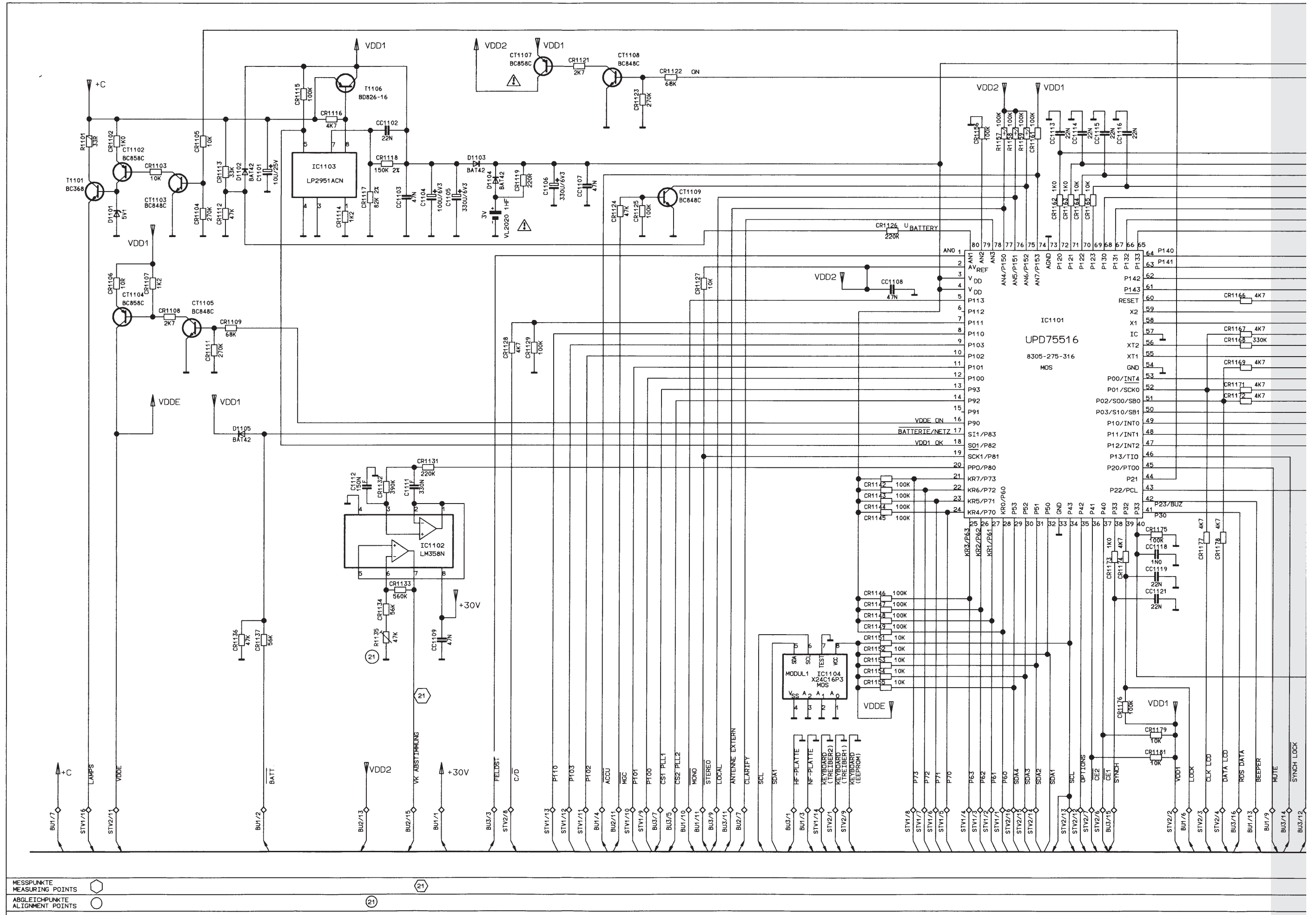

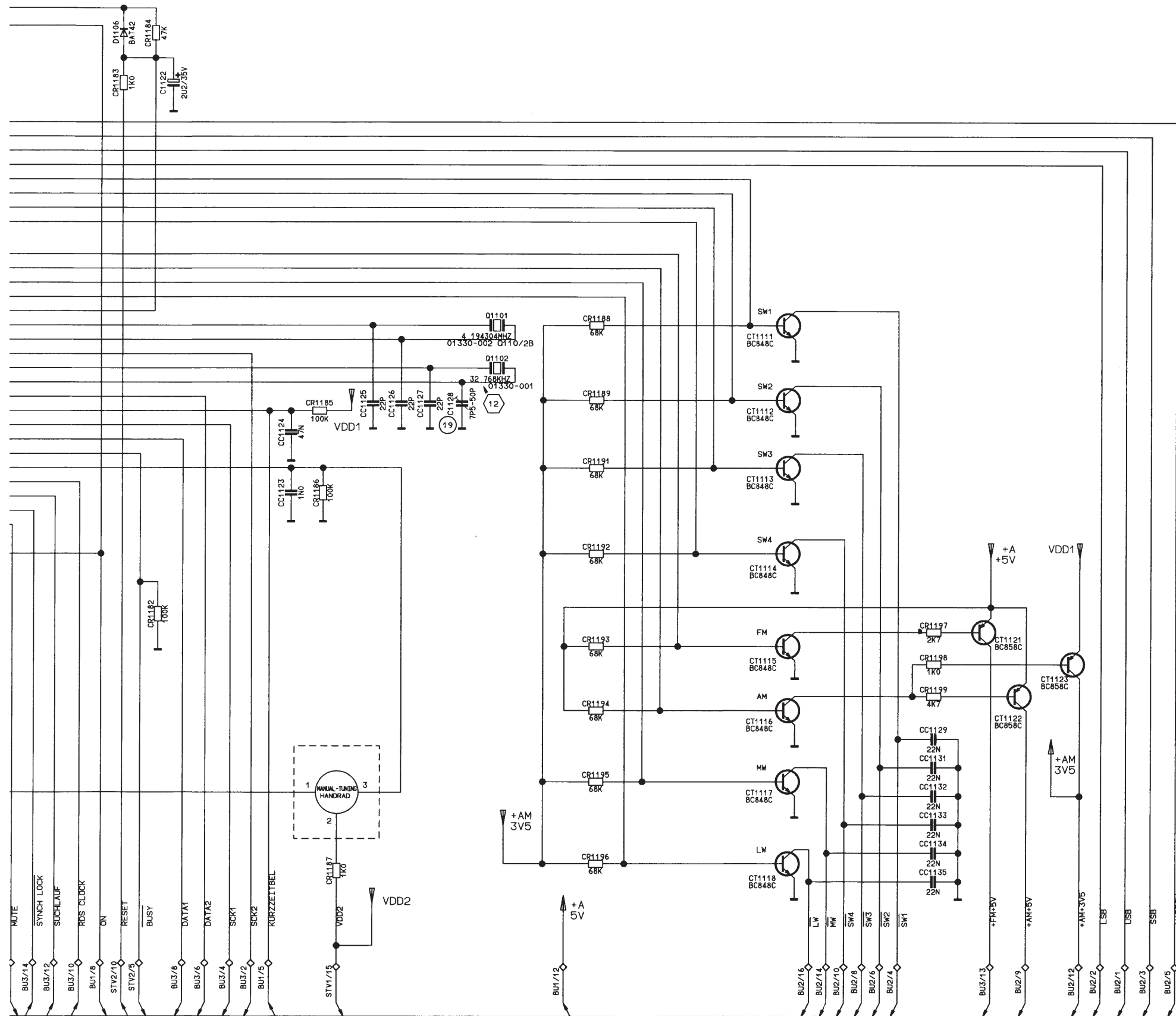

PROZESS PLATTE
 PROCESS BOARD
 C.I. PROCESS
 PIASTRA PROCESS
 PLACA DEL PROCESS
 19372-239.00

GRUNDIG
 Satellit 700

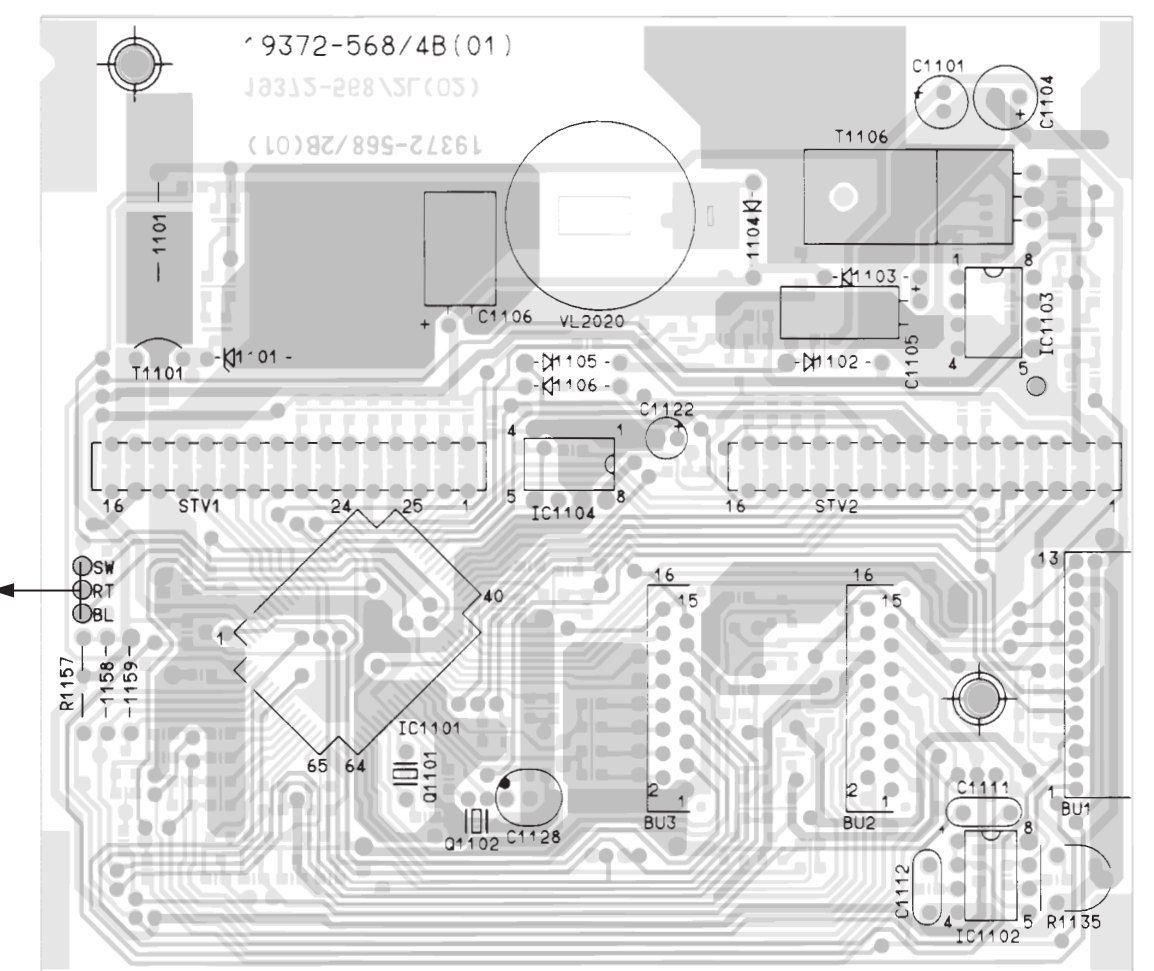
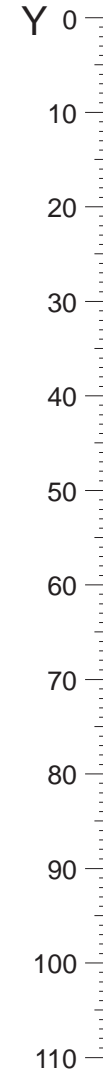
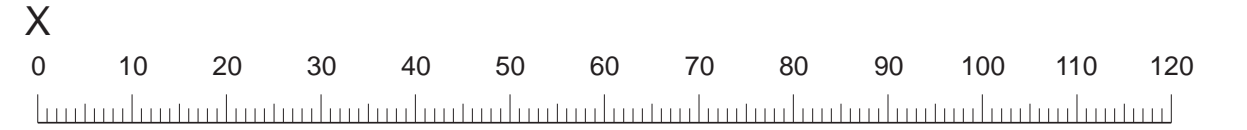
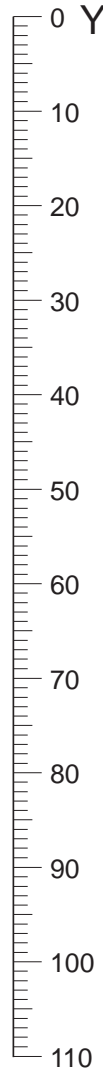
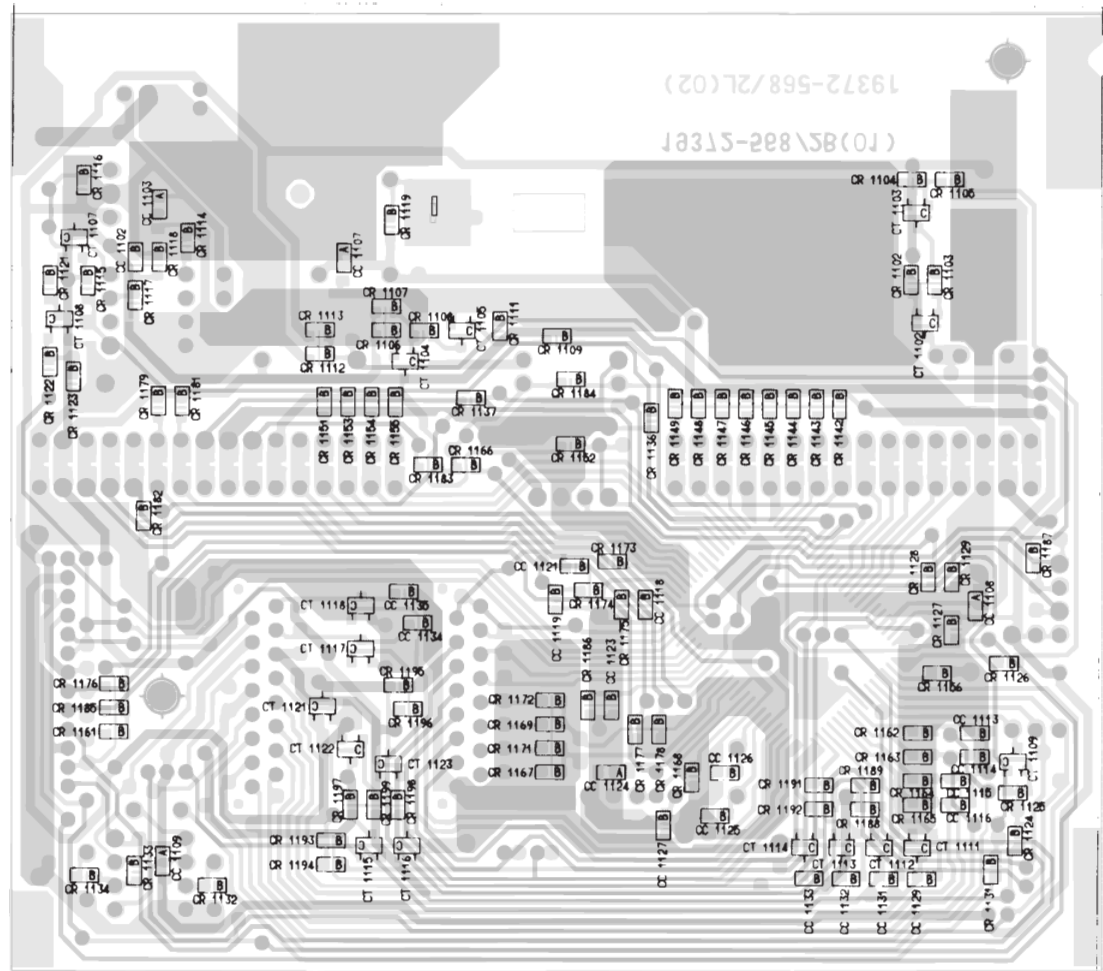
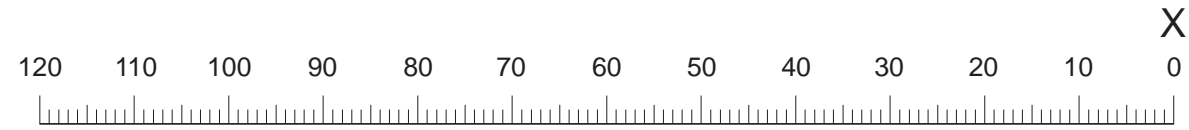

Bauteil	X	Y	Bauteil	X	Y	Bauteil	X	Y	Bauteil	X	Y	Bauteil	X	Y	Bauteil	X	Y
CC 1102	102	27	CR 1135	74	61	Bauteil	X	Y	CR 1154	77	42	CT 1108	110	33			
CC 1103	100	21	CR 1102	20	29	CR 1126	10	69	CR 1155	75	42	CT 1109	9	79			
CC 1107	80	27	CR 1103	18	29	CR 1127	16	65	CR 1156	17	70	CT 1111	19	88			
CC 1108	13	63	CR 1104	20	18	CR 1128	18	60	CR 1161	104	76	CT 1112	23	88			
CC 1109	99	90	CR 1105	16	18	CR 1129	16	60	CR 1162	19	76	CT 1113	27	88			
CC 1113	13	76	CR 1106	76	34	CR 1131	11	90	CR 1163	19	78	CT 1114	31	88			
CC 1114	13	78	CR 1107	76	32	CR 1132	94	92	CR 1164	19	81	CT 1115	77	88			
CC 1115	15	81	CR 1108	72	34	CR 1133	102	91	CR 1165	19	83	CT 1116	73	88			
CC 1116	15	83	CR 1109	58	35	CR 1134	107	91	CR 1166	67	48	CT 1117	78	67			
CC 1118	48	63	CR 1111	64	34	CR 1136	48	43	CR 1167	58	80	CT 1118	78	63			
CC 1119	58	62	CR 1112	83	37	CR 1137	67	41	CR 1168	43	81	CT 1121	82	73			
CC 1121	56	59	CR 1113	83	34	CR 1142	28	42	CR 1169	58	75	CT 1122	79	78			
CC 1123	52	73	CR 1114	97	25	CR 1143	30	42	CR 1171	58	78	CT 1123	75	79			
CC 1124	52	80	CR 1115	107	29	CR 1144	33	42	CR 1172	58	73						
CC 1125	41	85	CR 1116	108	19	CR 1145	35	42	CR 1173	52	58						
CC 1126	40	80	CR 1117	102	31	CR 1146	38	42	CR 1174	54	61						
CC 1127	46	86	CR 1118	100	27	CR 1147	40	42	CR 1175	51	63						
CC 1129	19	91	CR 1119	75	23	CR 1148	43	42	CR 1176	104	71						
CC 1131	23	91	CR 1121	111	29	CR 1149	45	42	CR 1177	49	76						
CC 1132	27	91	CR 1122	111	38	CR 1151	82	42	CR 1178	47	76						
CC 1133	31	91	CR 1123	109	39	CR 1152	56	46	CR 1179	100	42						
CC 1134	72	65	CR 1124	9	87	CR 1153	80	42	CR 1181	97	42						
									CR 1182	101	54	CT 1107	109	25			
									CR 1183	71	48						
									CR 1184	56	39						
									CR 1185	104	74						
									CR 1186	54	73						
									CR 1187	7	58						
									CR 1188	25	84						
									CR 1189	25	81						
									CR 1191	30	81						
									CR 1192	30	84						
									CR 1193	81	87						
									CR 1194	81	90						
									CR 1195	74	71						
									CR 1196	73	74						
									CR 1197	79	84						
									CR 1198	74	84						
									CR 1199	77	84						
									CT 1102	19	33						
									CT 1103	20	22						
									CT 1104	74	37						
									CT 1105	68	34						
									CT 1107	109	25						

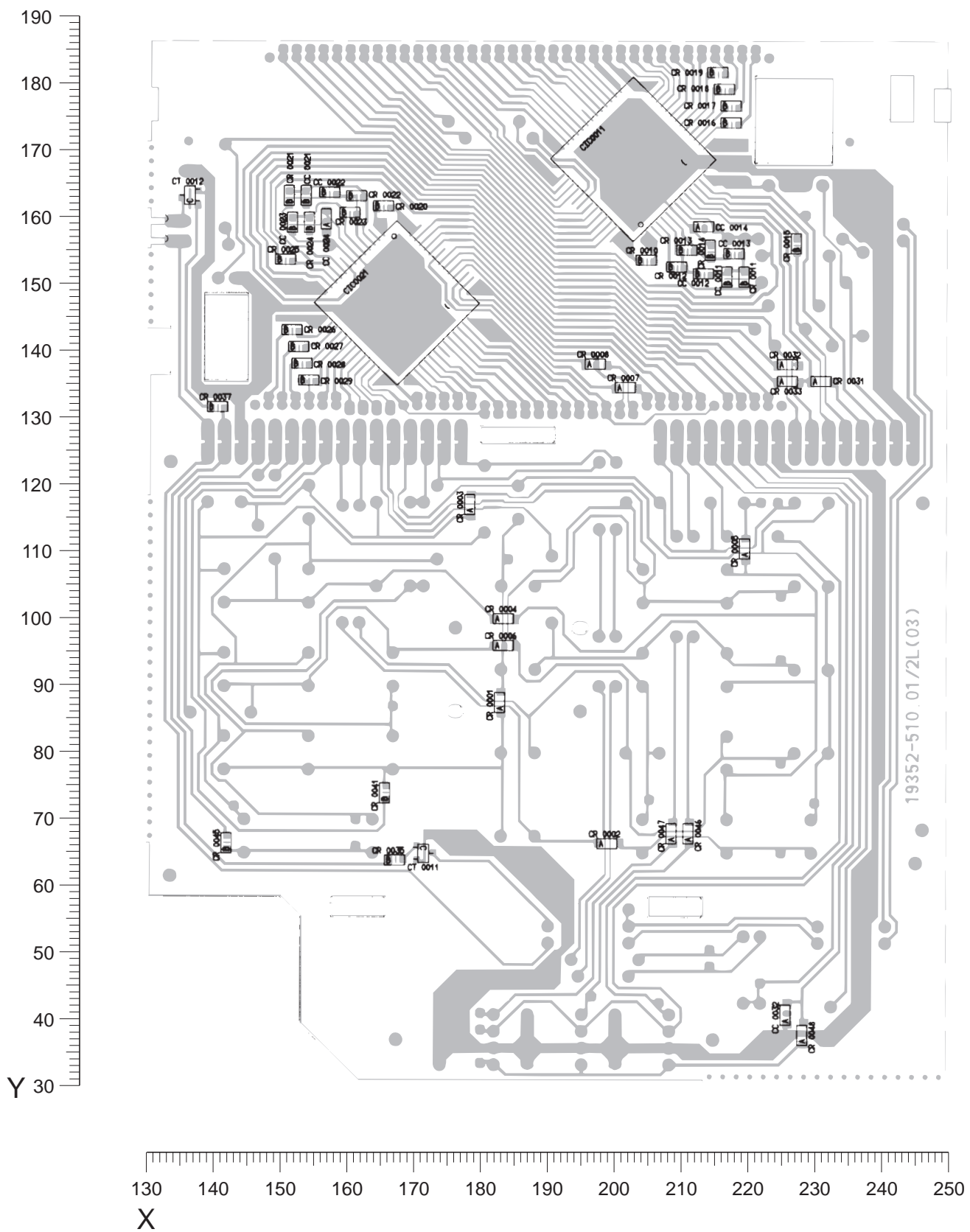

Bauteil	X	Y	Bauteil	X	Y	Bauteil	X	Y
CC 0011	217	151	CR 0007	202	134	CR 0025	151	153
CC 0012	213	151	CR 0008	197	138	CR 0026	152	143
CC 0013	218	154	CR 0010	205	153	CR 0027	153	140
CC 0014	213	158	CR 0011	219	151	CR 0028	154	138
CC 0021	154	163	CR 0012	209	152	CR 0029	155	135
CC 0022	158	163	CR 0013	211	155	CR 0031	231	135
CC 0023	152	159	CR 0014	214	155	CR 0032	226	138
CC 0024	157	159	CR 0015	227	156	CR 0033	226	135
CC 0032	226	41	CR 0016	217	174	CR 0035	168	64
CIC 0011	203	168	CR 0017	217	176	CR 0037	141	131
CIC 0021	168	147	CR 0018	216	179	CR 0041	166	74
CR 0001	183	87	CR 0019	215	181	CR 0045	143	66
CR 0002	199	66	CR 0020	166	161	CR 0046	211	68
CR 0003	179	117	CR 0021	152	163	CR 0047	209	68
CR 0004	184	100	CR 0022	162	163	CR 0048	228	38
CR 0005	219	110	CR 0023	161	160	CT 0011	172	65
CR 0006	184	96	CR 0024	155	159	CT 0012	137	163

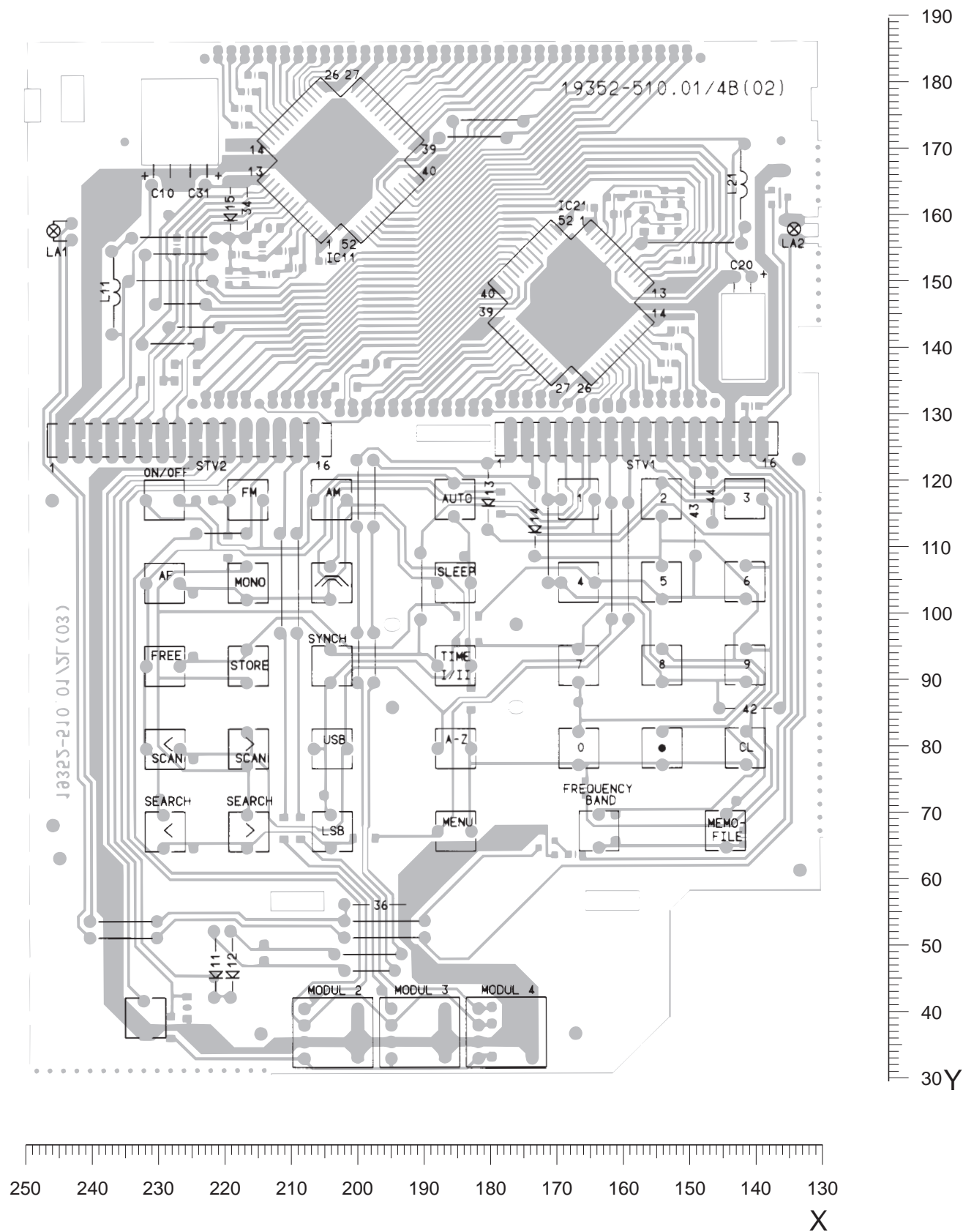

Bauteil	X	Y	Bauteil	X	Y	Bauteil	X	Y
IC 0011	152	152	IC 0021	152	152	CT 0011	172	65
CT 0011	172	65	CT 0012	137	163	CT 0012	137	163

LC-DISPLAY 19720-221.00

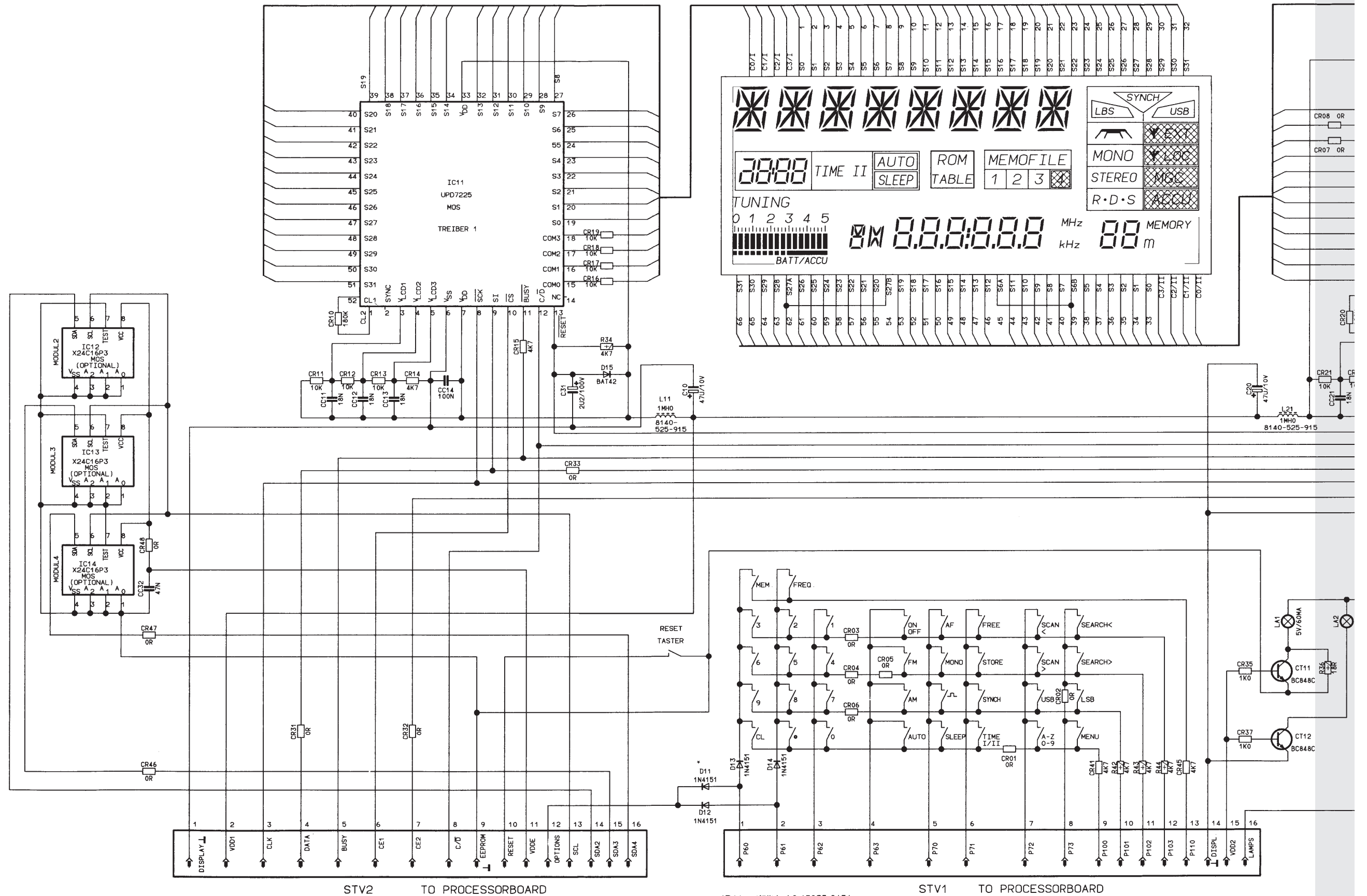

STV2 TO PROCESSORBOARD

*D11 entfällt bei 9.15055-6151

STV1 TO PROCESSORBOARD

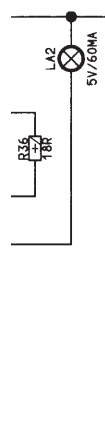
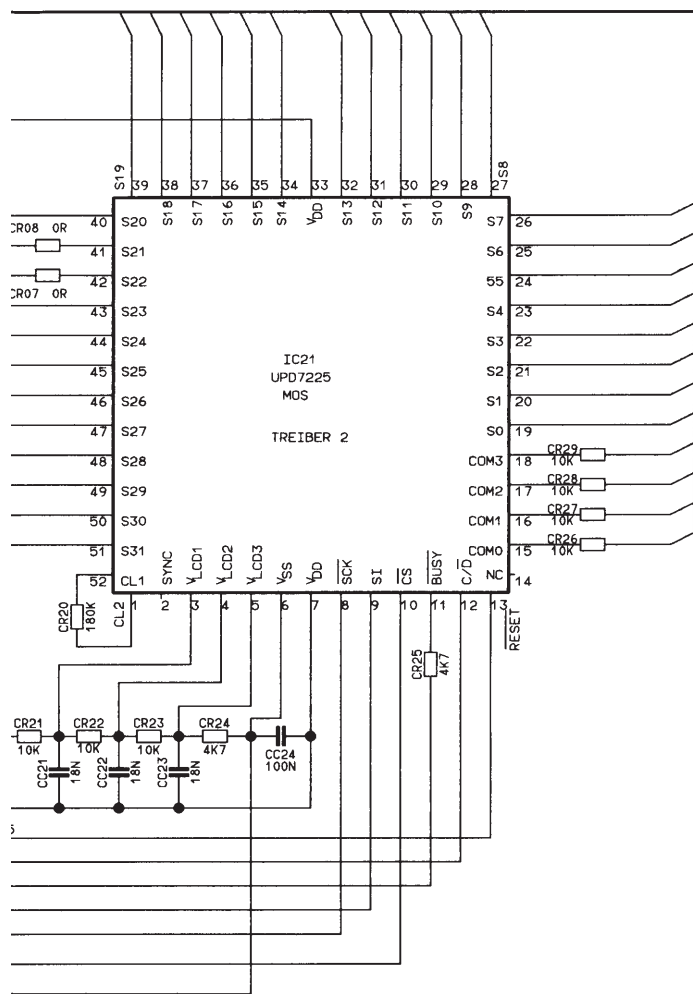

BEDIENPLATTE
OPERATING BOARD
C.I. COMMANDES
PIASTRA COMANDI
PLACA DE MANDOS
19352-258 93

GRUNDIG
Satellit 700

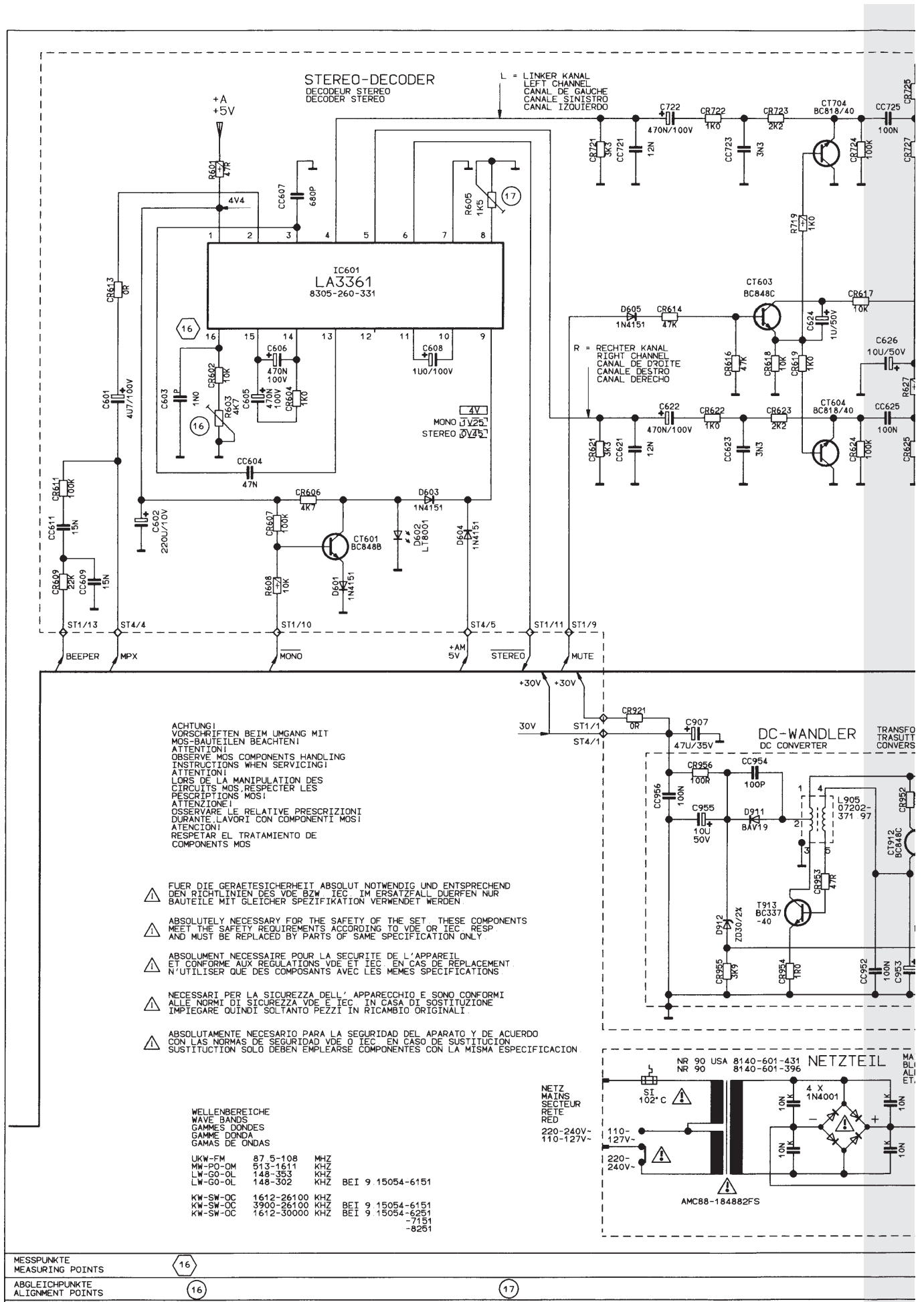

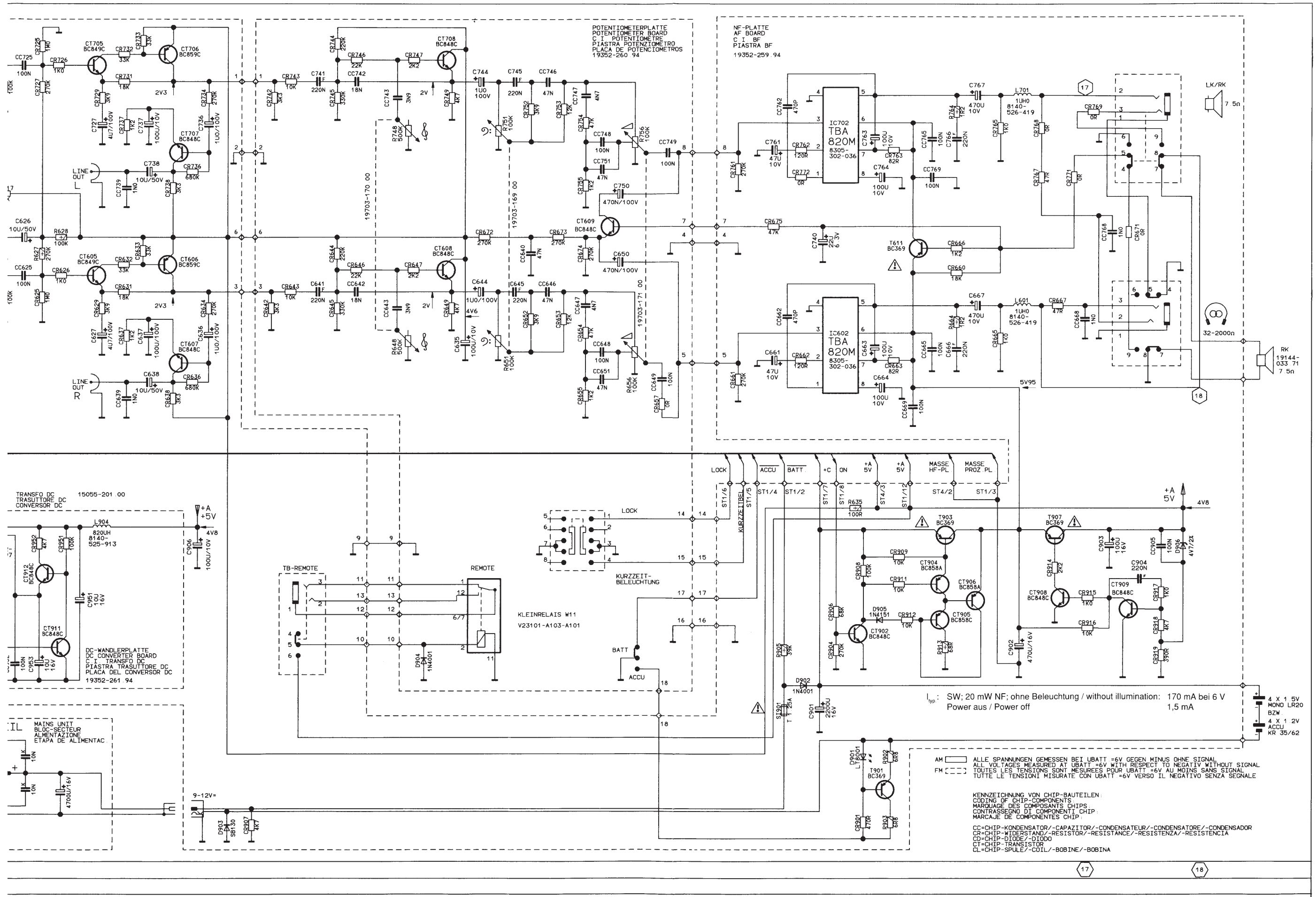

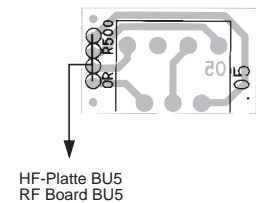
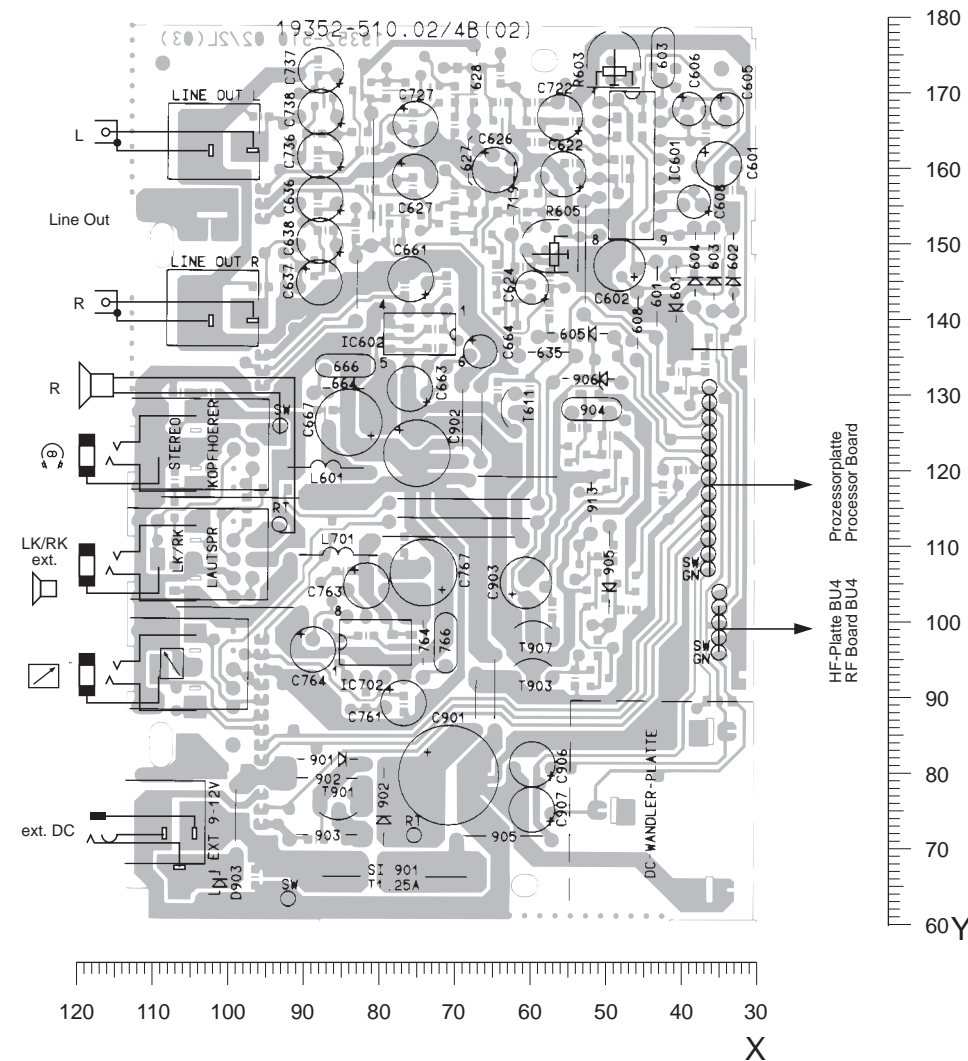

HF-Platte BU4
RF Board BU4

Prozessorplatte
Processor Board

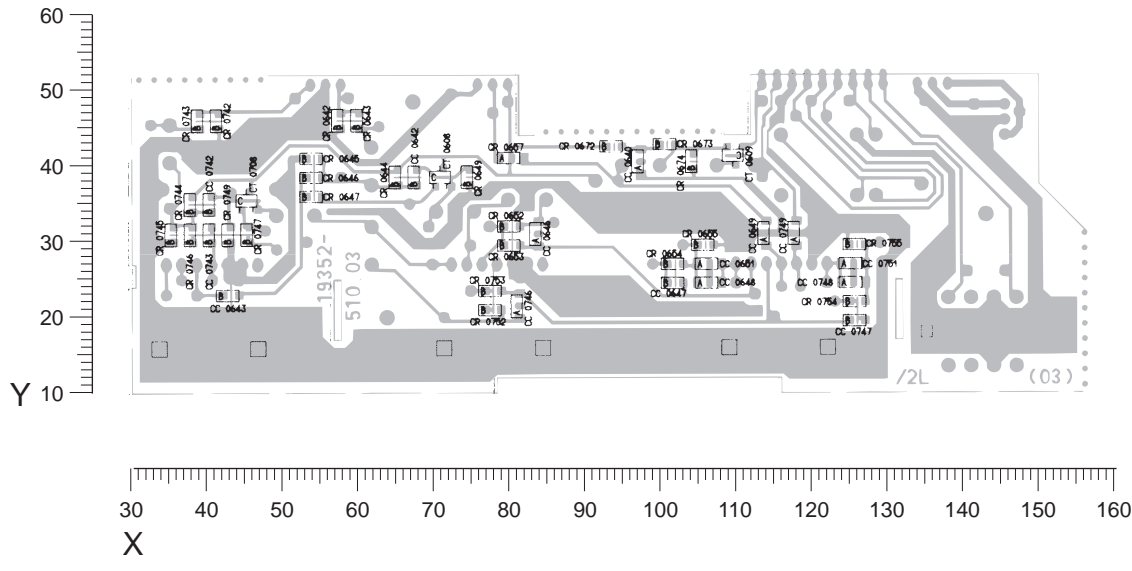
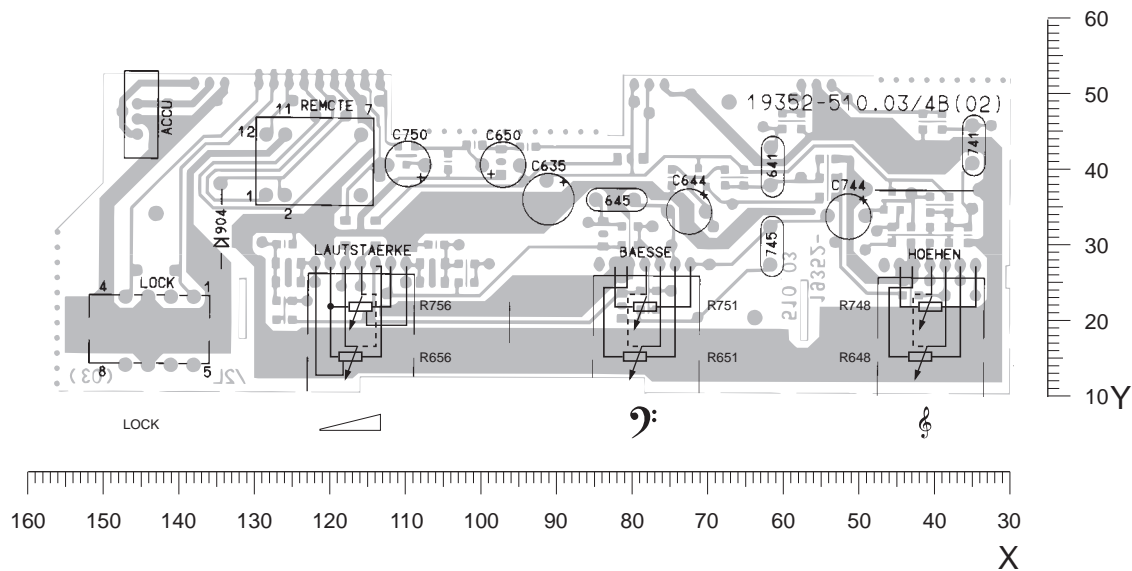
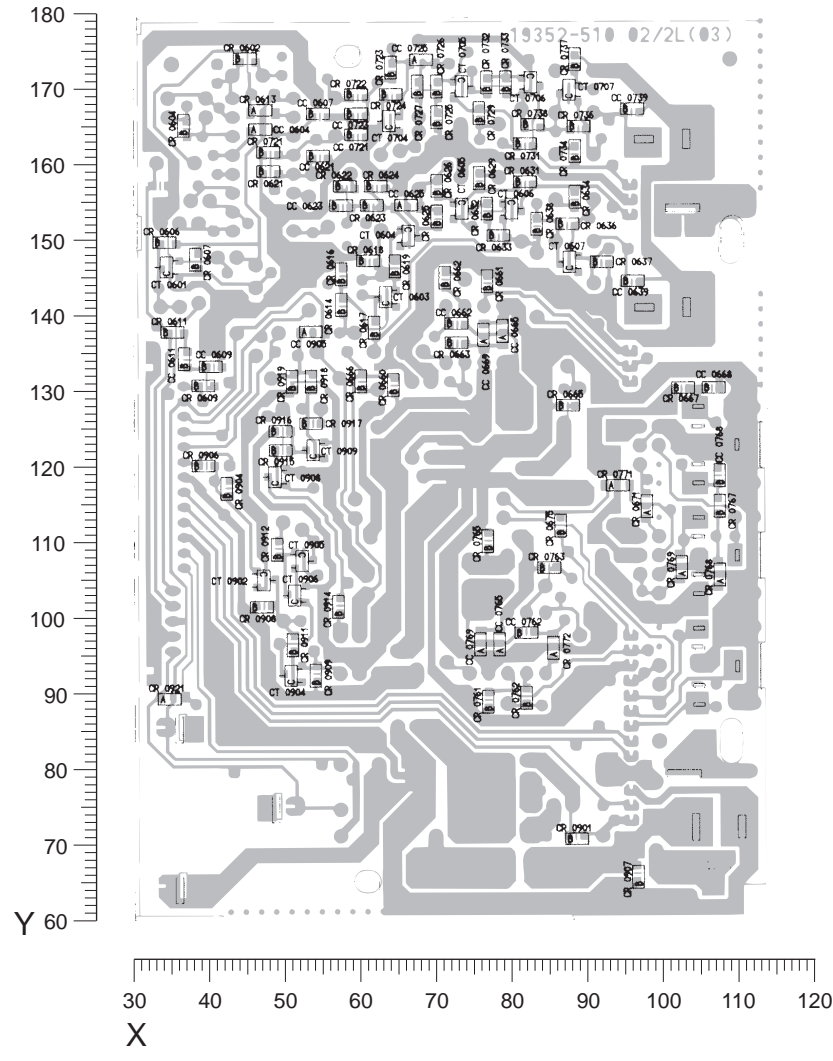

Bauteil	X	Y	Bauteil	X	Y	Bauteil	X	Y	Bauteil	X	Y	Bauteil	X	Y	Bauteil	X	Y	Bauteil	X	Y	Bauteil	X	Y	Bauteil	X	Y	
CC 0604	47	172	CC 0665	78	145	CC 0769	75	104	CR 0621	48	166	CR 0645	54	41	CR 0737	88	181	CR 0767	106	122	CR 0918	53	139	CT 0704	63	173	
CC 0607	54	174	CC 0668	106	138	CC 0905	53	145	CR 0622	58	164	CR 0646	54	39	CR 0738	82	172	CR 0768	106	113	CR 0919	51	139	CT 0705	73	177	
CC 0609	40	141	CC 0669	76	145	CC 0952	13	176	CR 0623	61	162	CR 0647	54	36	CR 0742	42	46	CR 0769	101	114	CR 0921	35	97	CT 0706	82	178	
CC 0611	37	142	CC 0721	59	171	CC 0954	23	172	CR 0624	62	164	CR 0649	75	39	CR 0743	39	46	CR 0771	93	125	CR 0951	20	180	CT 0707	87	177	
CC 0621	54	168	CC 0723	59	174	CC 0956	27	164	CR 0625	70	160	CR 0652	80	32	CR 0721	48	169	CR 0772	85	104	CR 0952	18	180	CT 0708	46	36	
CC 0623	57	162	CC 0725	68	181	CR 0602	45	181	CR 0626	70	164	CR 0653	80	30	CR 0722	59	176	CR 0901	88	80	CR 0953	17	165	CT 0902	47	113	
CC 0625	66	162	CC 0739	95	174	CR 0604	37	172	CR 0629	75	165	CR 0654	102	27	CR 0723	64	180	CR 0904	42	125	CR 0954	17	162	CT 0904	50	100	
CC 0639	95	152	CC 0742	41	35	CR 0606	34	157	CR 0631	81	165	CR 0655	106	30	CR 0724	64	176	CR 0906	39	128	CR 0955	27	180	CT 0905	52	115	
CC 0640	97	41	CC 0743	41	31	CR 0607	38	155	CR 0632	76	161	CR 0657	80	41	CR 0725	70	173	CR 0907	96	74	CR 0956	26	168	CT 0906	51	111	
CC 0642	68	39	CC 0746	81	22	CR 0609	39	138	CR 0633	78	158	CR 0660	64	138	CR 0726	70	177	CR 0908	47	109	CT 0601	34	154	CT 0908	48	126	
CC 0643	43	23	CC 0747	126	20	CR 0611	35	145	CR 0634	88	163	CR 0661	76	152	CR 0727	67	177	CR 0909	54	100	CT 0603	63	150	CT 0909	53	130	
CC 0646	84	31	CC 0748	125	25	CR 0613	47	174	CR 0636	87	159	CR 0662	71	152	CR 0729	75	174	CR 0911	51	104	CT 0604	66	158	CT 0911	24	182	
CC 0647	102	25	CC 0749	118	31	CR 0614	57	149	CR 0637	91	154	CR 0663	72	144	CR 0731	81	170	CR 0912	49	117	CT 0605	73	161	CT 0912	14	182	
CC 0648	106	25	CC 0751	125	27	CR 0616	57	153	CR 0638	83	159	CR 0665	87	135	CR 0732	76	178	CR 0914	57	109	CT 0606	79	161				
CC 0649	114	31	CC 0762	81	106	CR 0617	61	146	CR 0642	58	46	CR 0666	60	139	CR 0733	79	178	CR 0915	49	130	CT 0607	87	154				
CC 0651	106	27	CC 0765	78	104	CR 0618	61	154	CR 0643	60	46	CR 0667	102	138	CR 0734	88	169	CR 0916	49	132	CT 0608	71	39				
CC 0662	72	146	CC 0768	106	126	CR 0619	64	154	CR 0644	65	39	CR 0671	97	122	CR 0736	88	172	CR 0917	53	133	CT 0609	110	41				

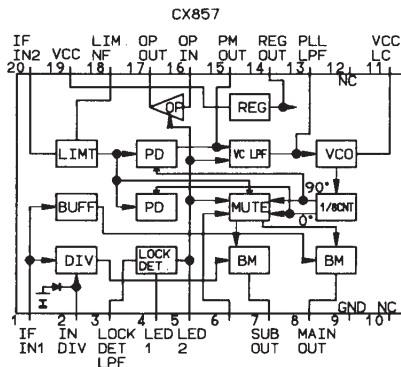
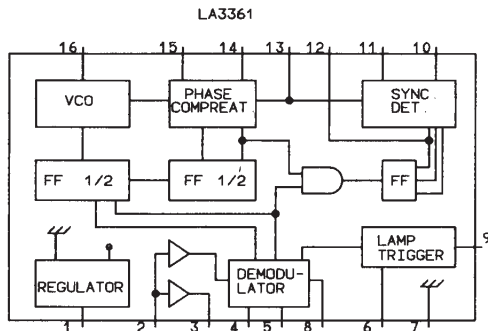
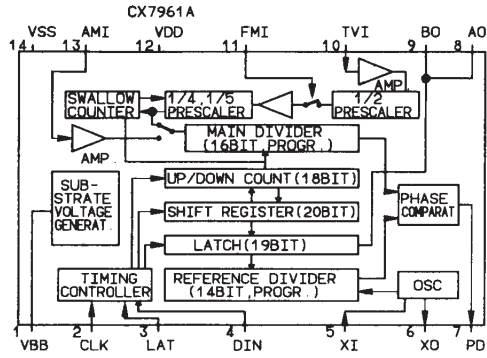

AENDERUNGEN VORBEHALTEN
 SUBJECT TO ALTERATION
 SOUS RESERVE DE MODIFIC.
 CON RISERVA DI MODIFICA
 RES. EL DERECHO DE MODIFIC.

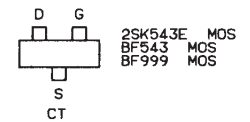
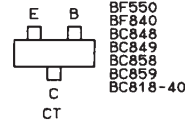
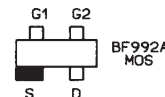
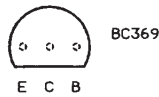
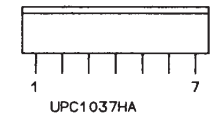
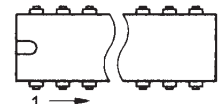
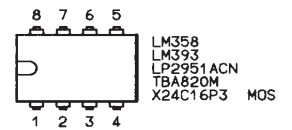
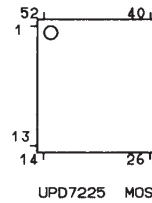
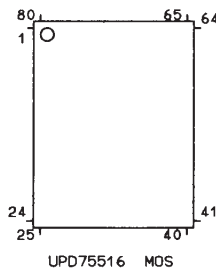
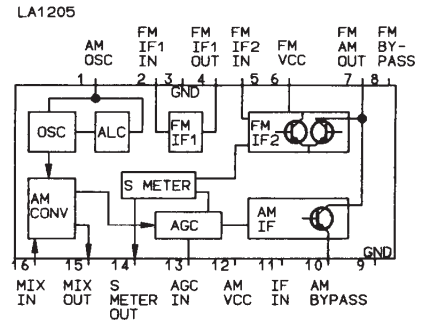

WIDERSTAND/RESISTOR
 RESISTANCE/RESISTENZA/RESISTENCIA

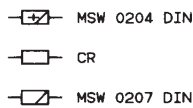

KONDENSATOR/CAPACITOR
 CONDENSATEUR/CONDENSATORE/CONDENSADOR

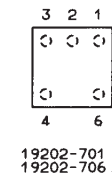
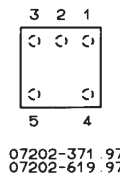
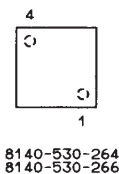
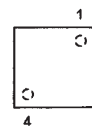
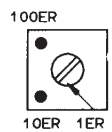
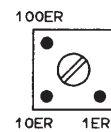
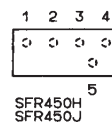
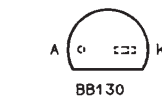
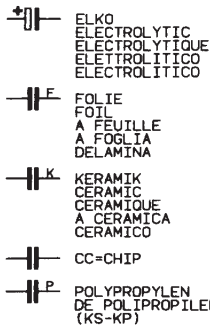

FARBKENNZEICHNUNG VON FILTERN
 COLOUR CODE FOR FILTERS
 REPERE EN COULEUR DES FILTRES
 CONTR. COLORATO SUI FILTRI
 CODIFICACION DE LOS FILTROS

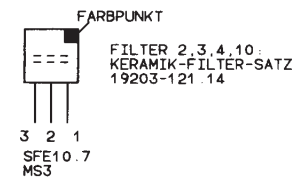

VON OBEN GESEHEN
 TOP VIEW
 VUE DE HAUT
 VISTA DA SOPRA
 VISTO DESDE ARRIBA

GRUNDIGErsatzteilliste
List of spare parts

D Btx ★ 32700 #

3 / 91





SATELLIT 700



SACH-NR. / PART NO.: 9.15055-8151 G.RB 6051 P
9.15055-6251 G.RB 6051 GB P
9.15055-7151 G.RB 6051 UB P
9.15055-6151 G.RB 6051 IB P

POS. NR. POS. NO.	ABB. NR. FIG. NO.	SACHNUMMER PART NUMBER	ANZ. QUA.	BEZEICHNUNG D	DESCRIPTION GB
0001.000	1	15055-095.01		GEHAEUSE-VORDERTEIL KPL	CABINET FRONT CPL.
0003.000	1	15055-035.00		TASTENSATZ KPL	KEYS SET CPL.
0006.000		15055-096.01		GEHAEUSE-RUECKTEIL KPL	CABINET BACK CPL.
0007.000		15041-017.05		STUETZKLAPPE	SUPPORT
0011.000		19401-078.00	35	TASTSCHALTER / BED.PL.	TACT SWITCH
0012.000	1	15054-098.01	4	DREHKNOPF KPL.	ROTARY KNOB CPL.
0013.000		09619-625.00	5	RINGFEDER	CIRCULAR SPRING
0014.000	1	15054-099.01		DREHKNOPF KPL.	ROTARY KNOB CPL.
0017.000		15054-040.00		DRUCKFEDER	COMPRESSION SPRING
0026.000		09234-143.04		MW-FERRITANTENNENSPULE	FERRITE COIL
0027.000		09234-209.02		ANTENNENSPULE	ANTENNA COIL (AERIAL)
0028.000		09234-419.01		LW-FERRITANTENNENSPULE	FERRITE COIL
0031.000		19706-083.00		SCHIEBESCHALTER /POTI PL.	SLIDING SWITCH
0032.000		19706-087.00		SCHIEBESCHALTER / LOCK.	SLIDE SWITCH
0033.000		19706-089.00	2	SCHIEBESCHALTER /HF. PL.	SLIDING SWITCH
0043.000		09648-910.97		ANTENNENSTAB	FERRIT ROD
0044.000	1	09622-819.01		TELESKOPANTENNE	TELESCOPIC AERIAL
0045.000		15054-029.00		ANTENNENWINKEL	AERIAL BRACKET
0046.000		19426-056.00		FERRITSTABANTENNE KPL.	FERRITE ROD ANTENNA CPL.
0054.000		29303-136.01		KOAXSTECKER	COAXIAL PLUG
0056.000		09623-436.00		BUCHSE	SOCKET
0057.000		09623-410.00		CINCHBUCHSE	CHINCH SOCKET
0058.000		09623-383.00		FREMDSPANNUNGSBUCHSE	EXTERNAL VOLTAGE SOCKET
0059.000		09623-387.00		BUCHSE (KOPFHÖRER)	HEADPHONE SOCKET
0061.000		15055-100.00		DC-WANDLER KPL.	DC CONVERTER CPL.
0063.000		09618-103.00		KONTAKTFEDER	CONTACT SPRING
0066.000		15054-048.00		BATTERIEABDECKUNG	BATTERY COVER
0067.000		15054-102.01		BATTERIEDECKEL KPL.	BATTERY LID CPL.
0069.000	△	8154-005-069		LITHIUM-BATTERIE	LITHIUM BATTERY
0072.000		19144-033.97		LAUTSPRECHER	LOUDSPEAKER
0078.000		15054-014.01		GRIFF	HANDLE
0079.000		15054-034.01		HAUBE	COVER
0080.000		15055-202.00		BEDIENTEIL	CONTROL UNIT
0081.000	△	8140-601-396		NETZTEIL NR 90	POWER SUPPLY NO.90
0081.100	△	8140-601-431		NETZTEIL NR 90 USA	POWER SUPPLY NO.90 USA
0082.000		09621-113.02	2	SICHERUNGSHALTER	FUSE HOLDER
0085.000		19720-221.00		FLUESSIGKRISTALLANZEIGE	LIQUID CRYSTAL DISPLAY
0086.000		8312-001-530		RELAIS V 23101-A103-A101	RELAY V 23101-A103-A101
0087.000		19411-008.00		IMPULSGEBER	IMPULS MODULE
		15055-941.01		BEDIENUNGSANLEITUNG	INSTRUCTION MANUAL
		72010-719.55		SERVICE MANUAL	SERVICE MANUAL

ÄNDERUNGEN VORBEHALTEN



ALTERNATIONS RESERVED

POS. NR.	SACHNUMMER	BEZEICHNUNG 
POS. NO.	PART NUMBER	DESCRIPTION 
		
C 127	8699-999-335	TR.12 3/10PF VCT 56
C 138	8699-999-345	TR.13 4,5/20PF VCT 56
C 154	8699-999-356	TR.15 7,5/50PF VCT 56
C 209	8699-999-345	TR.13 4,5/20PF VCT 56
C 213	8699-999-356	TR.15 7,5/50PF VCT 56
C 224	8699-999-348	TR.14 5,5/30PF VCT 56
C 226	8699-999-348	TR.14 5,5/30PF VCT 56
C 231	8699-999-356	TR.15 7,5/50PF VCT 56
C 233	8699-999-356	TR.15 7,5/50PF VCT 56
C 237	8699-999-356	TR.15 7,5/50PF VCT 56
C 241	8699-999-356	TR.15 7,5/50PF VCT 56
C 243	8699-999-356	TR.15 7,5/50PF VCT 56
C 246	8699-999-356	TR.15 7,5/50PF VCT 56
C 304	8699-999-345	TR.13 4,5/20PF VCT 56
C 324	8699-999-333	TR.11 2,5/6PF VCT 56
C 403	8699-999-333	TR.11 2,5/6PF VCT 56
C 531	8699-999-337	TR.2 3,5/10PF VCT 31
C 818	8699-999-345	TR.13 4,5/20PF VCT 56
C 901	8452-996-107	ELKO CB 2200UF 16V
C 1128	8699-999-356	TR.15 7,5/50PF VCT 56
CC 11	8672-167-261	KEFQ 0805 0,018UF 10%
CC 12	8672-167-261	KEFQ 0805 0,018UF 10%
CC 13	8672-167-261	KEFQ 0805 0,018UF 10%
CC 21	8672-167-261	KEFQ 0805 0,018UF 10%
CC 22	8672-167-261	KEFQ 0805 0,018UF 10%
CC 23	8672-167-261	KEFQ 0805 0,018UF 10%
CC 32	8672-267-179	KEFQ 1206 0,047UF 10%
CC 104	8672-267-179	KEFQ 1206 0,047UF 10%
CC 106	8672-167-262	KEFQ 0805 0,022UF 10%
CC 111	8672-167-246	KEFQ 0805 1000PF 10%
CC 115	8672-167-246	KEFQ 0805 1000PF 10%
CC 118	8672-267-179	KEFQ 1206 0,047UF 10%
CC 119	8672-167-262	KEFQ 0805 0,022UF 10%
CC 121	8672-160-122	KEFQ 0805 10PF 5%
CC 122	8672-160-146	KEFQ 0805 1000PF 5%
CC 126	8672-198-173	KEFQ 0805 0,01 UF 10%
CC 128	8672-160-130	KEFQ 0805 47PF 5%
CC 133	8672-267-179	KEFQ 1206 0,047UF 10%
CC 135	8672-167-262	KEFQ 0805 0,022UF 10%
CC 136	8672-160-133	KEFQ 0805 82PF 5%
CC 137	8672-160-127	KEFQ 0805 27PF 5%
CC 141	8672-160-122	KEFQ 0805 10PF 5%
CC 142	8672-160-146	KEFQ 0805 1000PF 5%
CC 143	8672-160-122	KEFQ 0805 10PF 5%
CC 145	8672-267-187	KEFQ 1206 0,1 UF 10%
CC 146	8672-167-262	KEFQ 0805 0,022UF 10%
CC 147	8672-197-595	KEFQ 0805 3,3PF
CC 148	8672-160-127	KEFQ 0805 27PF 5%
CC 149	8672-160-129	KEFQ 0805 39PF 5%
CC 150	8672-160-131	KEFQ 0805 56PF 5%
CC 151	8672-160-124	KEFQ 0805 15PF 5%
CC 152	8672-267-187	KEFQ 1206 0,1 UF 10%
CC 153	8672-198-173	KEFQ 0805 0,01 UF 10%
CC 155	8672-160-146	KEFQ 0805 1000PF 5%
CC 201	8672-160-138	KEFQ 0805 220PF 5%
CC 202	8672-160-126	KEFQ 0805 22PF 5%
CC 203	8672-198-173	KEFQ 0805 0,01 UF 10%
CC 204	8672-160-135	KEFQ 0805 120PF 5%
CC 205	8672-167-262	KEFQ 0805 0,022UF 10%
CC 206	8672-167-262	KEFQ 0805 0,022UF 10%
CC 207	8672-167-246	KEFQ 0805 1000PF 10%
CC 208	8672-167-262	KEFQ 0805 0,022UF 10%
CC 211	8672-267-187	KEFQ 1206 0,1 UF 10%
CC 212	8672-267-187	KEFQ 1206 0,1 UF 10%
CC 214	8672-267-187	KEFQ 1206 0,1 UF 10%
CC 215	8672-267-187	KEFQ 1206 0,1 UF 10%





POS. NR.	SACHNUMMER	BEZEICHNUNG 
POS. NO.	PART NUMBER	DESCRIPTION 
CC 216	8672-267-187	KEFQ 1206 0,1 UF 10%
CC 217	8672-267-187	KEFQ 1206 0,1 UF 10%
CC 218	8672-160-128	KEFQ 0805 33PF 5%
CC 219	8672-160-135	KEFQ 0805 120PF 5%
CC 221	8672-167-246	KEFQ 0805 1000PF 10%
CC 222	8672-267-187	KEFQ 1206 0,1 UF 10%
CC 223	8672-160-123	KEFQ 0805 12PF 5%
CC 225	8672-198-173	KEFQ 0805 0,01 UF 10%
CC 227	8672-267-187	KEFQ 1206 0,1 UF 10%
CC 228	8672-267-187	KEFQ 1206 0,1 UF 10%
CC 229	8672-160-130	KEFQ 0805 47PF 5%
CC 232	8672-198-173	KEFQ 0805 0,01 UF 10%
CC 234	8672-160-126	KEFQ 0805 22PF 5%
CC 235	8672-267-187	KEFQ 1206 0,1 UF 10%
CC 236	8672-160-146	KEFQ 0805 1000PF 5%
CC 238	8672-167-247	KEFQ 0805 1200PF 10%
CC 239	8672-167-247	KEFQ 0805 1200PF 10%
CC 241	8672-267-187	KEFQ 1206 0,1 UF 10%
CC 242	8672-267-187	KEFQ 1206 0,1 UF 10%
CC 244	8672-160-134	KEFQ 0805 100PF 5%
CC 245	8672-160-134	KEFQ 0805 100PF 5%
CC 247	8672-267-187	KEFQ 1206 0,1 UF 10%
CC 249	8672-267-179	KEFQ 1206 0,047UF 10%
CC 254	8672-160-144	KEFQ 0805 680PF 5%
CC 258	8672-267-179	KEFQ 1206 0,047UF 10%
CC 259	8672-198-173	KEFQ 0805 0,01 UF 10%
CC 301	8672-160-123	KEFQ 0805 12PF 5%
CC 305	8672-167-252	KEFQ 0805 3300PF 10%
CC 306	8672-160-142	KEFQ 0805 470PF 5%
CC 307	8672-167-252	KEFQ 0805 3300PF 10%
CC 308	8672-167-252	KEFQ 0805 3300PF 10%
CC 311	8672-160-123	KEFQ 0805 12PF 5%
CC 314	8672-160-141	KEFQ 0805 390PF 5%
CC 315	8672-198-173	KEFQ 0805 0,01 UF 10%
CC 316	8672-198-173	KEFQ 0805 0,01 UF 10%
CC 318	8672-167-246	KEFQ 0805 1000PF 10%
CC 319	8672-267-179	KEFQ 1206 0,047UF 10%
CC 321	8672-167-254	KEFQ 0805 4700PF 10%
CC 322	8672-160-146	KEFQ 0805 1000PF 5%
CC 326	8672-167-252	KEFQ 0805 3300PF 10%
CC 327	8672-160-126	KEFQ 0805 22PF 5%
CC 329	8672-160-146	KEFQ 0805 1000PF 5%
CC 331	8672-198-173	KEFQ 0805 0,01 UF 10%
CC 334	8672-167-252	KEFQ 0805 3300PF 10%
CC 402	8672-160-017	KEFQ 0805 3,9PF
CC 404	8672-160-127	KEFQ 0805 27PF 5%
CC 405	8672-160-122	KEFQ 0805 10PF 5%
CC 406	8672-167-254	KEFQ 0805 4700PF 10%
CC 407	8672-267-179	KEFQ 1206 0,047UF 10%
CC 408	8672-160-123	KEFQ 0805 12PF 5%
CC 411	8672-160-122	KEFQ 0805 10PF 5%
CC 412	8672-160-130	KEFQ 0805 47PF 5%
CC 413	8672-160-132	KEFQ 0805 68PF 5%
CC 414	8672-160-135	KEFQ 0805 120PF 5%
CC 415	8672-160-133	KEFQ 0805 82PF 5%
CC 419	8672-160-146	KEFQ 0805 1000PF 5%
CC 421	8672-160-146	KEFQ 0805 1000PF 5%
CC 423	8672-267-187	KEFQ 1206 0,1 UF 10%
CC 424	8672-167-262	KEFQ 0805 0,022UF 10%
CC 425	8672-167-246	KEFQ 0805 1000PF 10%
CC 427	8672-198-173	KEFQ 0805 0,01 UF 10%
CC 428	8672-198-173	KEFQ 0805 0,01 UF 10%
CC 429	8672-160-146	KEFQ 0805 1000PF 5%
CC 431	8672-160-131	KEFQ 0805 56PF 5%
CC 434	8672-198-173	KEFQ 0805 0,01 UF 10%
CC 435	8672-198-173	KEFQ 0805 0,01 UF 10%
CC 436	8672-160-139	KEFQ 0805 270PF 5%
CC 437	8672-267-187	KEFQ 1206 0,1 UF 10%
CC 438	8672-267-179	KEFQ 1206 0,047UF 10%

ÄNDERUNGEN VORBEHALTEN



ALTERNATIONS RESERVED

POS. NR.	SACHNUMMER	BEZEICHNUNG 
POS. NO.	PART NUMBER	DESCRIPTION 
CC 439	8672-267-179	KEFQ 1206 0,047UF 10%
CC 441	8672-267-179	KEFQ 1206 0,047UF 10%
CC 452	8672-198-173	KEFQ 0805 0,01 UF 10%
CC 453	8672-167-246	KEFQ 0805 1000PF 10%
CC 501	8672-267-179	KEFQ 1206 0,047UF 10%
CC 503	8672-267-179	KEFQ 1206 0,047UF 10%
CC 504	8672-198-173	KEFQ 0805 0,01 UF 10%
CC 505	8672-260-147	KEFQ 1206 1200PF 5%
CC 506	8672-198-173	KEFQ 0805 0,01 UF 10%
CC 507	8672-267-179	KEFQ 1206 0,047UF 10%
CC 510	8672-160-146	KEFQ 0805 1000PF 5%
CC 513	8672-198-173	KEFQ 0805 0,01 UF 10%
CC 514	8672-198-173	KEFQ 0805 0,01 UF 10%
CC 515	8672-160-126	KEFQ 0805 22PF 5%
CC 516	8672-260-147	KEFQ 1206 1200PF 5%
CC 517	8672-198-173	KEFQ 0805 0,01 UF 10%
CC 519	8672-160-126	KEFQ 0805 22PF 5%
CC 521	8672-160-126	KEFQ 0805 22PF 5%
CC 522	8672-160-134	KEFQ 0805 100PF 5%
CC 525	8672-160-138	KEFQ 0805 220PF 5%
CC 527	8672-198-173	KEFQ 0805 0,01 UF 10%
CC 532	8672-167-246	KEFQ 0805 1000PF 10%
CC 604	8672-267-179	KEFQ 1206 0,047UF 10%
CC 607	8672-160-244	KEFQ 0805 680PF 10%
CC 609	8672-167-260	KEFQ 0805 0,015UF 10%
CC 611	8672-167-260	KEFQ 0805 0,015UF 10%
CC 621	8672-167-259	KEFQ 0805 0,012UF 10%
CC 625	8672-267-187	KEFQ 1206 0,1 UF 10%
CC 639	8672-167-246	KEFQ 0805 1000PF 10%
CC 642	8672-167-261	KEFQ 0805 0,018UF 10%
CC 643	8672-167-253	KEFQ 0805 3900PF 10%
CC 646	8672-267-179	KEFQ 1206 0,047UF 10%
CC 647	8672-167-254	KEFQ 0805 4700PF 10%
CC 648	8672-267-187	KEFQ 1206 0,1 UF 10%
CC 649	8672-267-187	KEFQ 1206 0,1 UF 10%
CC 651	8672-267-179	KEFQ 1206 0,047UF 10%
CC 662	8672-197-141	KEFQ 0805 470PF 10%
CC 665	8672-267-187	KEFQ 1206 0,1 UF 10%
CC 668	8672-167-246	KEFQ 0805 1000PF 10%
CC 669	8672-267-187	KEFQ 1206 0,1 UF 10%
CC 721	8672-167-259	KEFQ 0805 0,012UF 10%
CC 725	8672-267-187	KEFQ 1206 0,1 UF 10%
CC 739	8672-167-246	KEFQ 0805 1000PF 10%
CC 742	8672-167-261	KEFQ 0805 0,018UF 10%
CC 743	8672-167-253	KEFQ 0805 3900PF 10%
CC 746	8672-267-179	KEFQ 1206 0,047UF 10%
CC 747	8672-167-254	KEFQ 0805 4700PF 10%
CC 748	8672-267-187	KEFQ 1206 0,1 UF 10%
CC 749	8672-267-187	KEFQ 1206 0,1 UF 10%
CC 751	8672-267-179	KEFQ 1206 0,047UF 10%
CC 762	8672-197-141	KEFQ 0805 470PF 10%
CC 765	8672-267-187	KEFQ 1206 0,1 UF 10%
CC 768	8672-167-246	KEFQ 0805 1000PF 10%
CC 769	8672-267-187	KEFQ 1206 0,1 UF 10%
CC 801	8672-198-173	KEFQ 0805 0,01 UF 10%
CC 802	8672-198-173	KEFQ 0805 0,01 UF 10%
CC 803	8672-160-132	KEFQ 0805 68PF 5%
CC 804	8672-160-132	KEFQ 0805 68PF 5%
CC 807	8672-198-173	KEFQ 0805 0,01 UF 10%
CC 808	8672-198-173	KEFQ 0805 0,01 UF 10%
CC 809	8672-198-173	KEFQ 0805 0,01 UF 10%
CC 811	8672-160-146	KEFQ 0805 1000PF 5%
CC 813	8672-198-173	KEFQ 0805 0,01 UF 10%
CC 814	8672-198-173	KEFQ 0805 0,01 UF 10%
CC 817	8672-198-173	KEFQ 0805 0,01 UF 10%
CC 821	8672-160-134	KEFQ 0805 100PF 5%
CC 822	8672-160-141	KEFQ 0805 390PF 5%
CC 823	8672-267-187	KEFQ 1206 0,1 UF 10%
CC 824	8672-160-146	KEFQ 0805 1000PF 5%



ÄNDERUNGEN VORBEHALTEN

POS. NR.	SACHNUMMER	BEZEICHNUNG 
POS. NO.	PART NUMBER	DESCRIPTION 
CC 827	8672-167-250	KEFQ 0805 2200PF 10%
CC 828	8672-198-173	KEFQ 0805 0,01 UF 10%
CC 829	8672-160-145	KEFQ 0805 820PF 5%
CC 831	8672-167-250	KEFQ 0805 2200PF 10%
CC 832	8672-198-173	KEFQ 0805 0,01 UF 10%
CC 833	8672-160-145	KEFQ 0805 820PF 5%
CC 839	8672-267-187	KEFQ 1206 0,1 UF 10%
CC 843	8672-267-187	KEFQ 1206 0,1 UF 10%
CC 905	8672-267-187	KEFQ 1206 0,1 UF 10%
CC 952	8672-267-287	KEFQ 1206 0,1 UF 20%
CC 954	8672-160-134	KEFQ 0805 100PF 5%
CC 956	8672-267-287	KEFQ 1206 0,1 UF 20%
CC 1001	8672-167-262	KEFQ 0805 0,022UF 10%
CC 1004	8672-160-135	KEFQ 0805 120PF 5%
CC 1005	8672-160-135	KEFQ 0805 120PF 5%
CC 1008	8672-160-129	KEFQ 0805 39PF 5%
CC 1009	8672-160-134	KEFQ 0805 100PF 5%
CC 1102	8672-198-173	KEFQ 0805 0,01 UF 10%
CC 1103	8672-267-179	KEFQ 1206 0,047UF 10%
CC 1107	8672-267-179	KEFQ 1206 0,047UF 10%
CC 1108	8672-267-179	KEFQ 1206 0,047UF 10%
CC 1109	8672-267-179	KEFQ 1206 0,047UF 10%
CC 1113	8672-167-262	KEFQ 0805 0,022UF 10%
CC 1114	8672-167-262	KEFQ 0805 0,022UF 10%
CC 1115	8672-167-262	KEFQ 0805 0,022UF 10%
CC 1116	8672-167-262	KEFQ 0805 0,022UF 10%
CC 1118	8672-167-246	KEFQ 0805 1000PF 10%
CC 1119	8672-167-262	KEFQ 0805 0,022UF 10%
CC 1121	8672-167-262	KEFQ 0805 0,022UF 10%
CC 1123	8672-167-246	KEFQ 0805 1000PF 10%
CC 1124	8672-267-179	KEFQ 1206 0,047UF 10%
CC 1125	8672-160-126	KEFQ 0805 22PF 5%
CC 1126	8672-160-126	KEFQ 0805 22PF 5%
CC 1127	8672-160-126	KEFQ 0805 22PF 5%
CC 1129	8672-167-262	KEFQ 0805 0,022UF 10%
CC 1131	8672-167-262	KEFQ 0805 0,022UF 10%
CC 1132	8672-167-262	KEFQ 0805 0,022UF 10%
CC 1133	8672-167-262	KEFQ 0805 0,022UF 10%
CC 1134	8672-167-262	KEFQ 0805 0,022UF 10%
CC 1135	8672-167-262	KEFQ 0805 0,022UF 10%
		
CIC1001	8305-303-779	IC SAF 7579 T (SO-16L)PHI
CIC801	8305-258-857	IC CX 857 L SONY
		
CL 201	8140-526-477	L-CHIP 1206 0,82UH
CL 202	8140-526-477	L-CHIP 1206 0,82UH
CL 203	8140-526-478	L-CHIP 1206 3,3UH
CL 303	8140-526-472	L-CHIP 1206 2,2UH
CL 306	8140-526-476	L-CHIP 1206 0,47UH
CL 403	8140-526-474	L-CHIP 1206 0,39UH
		
CR 01	8706-297-000	R-CHIP 1206 0 OHM
CR 02	8706-297-000	R-CHIP 1206 0 OHM
CR 03	8706-297-000	R-CHIP 1206 0 OHM
CR 04	8706-297-000	R-CHIP 1206 0 OHM
CR 05	8706-297-000	R-CHIP 1206 0 OHM
CR 06	8706-297-000	R-CHIP 1206 0 OHM
CR 07	8706-297-000	R-CHIP 1206 0 OHM
CR 08	8706-297-000	R-CHIP 1206 0 OHM
CR 10	8706-100-127	R-CHIP 0805 180 KOHM 5%
CR 11	8706-100-097	R-CHIP 0805 10 KOHM 5%
CR 12	8706-100-097	R-CHIP 0805 10 KOHM 5%



ALTERNATIONS RESERVED

POS. NR.	SACHNUMMER	BEZEICHNUNG 
POS. NO.	PART NUMBER	DESCRIPTION 
CR 13	8706-100-097	R-CHIP 0805 10 KOHM 5%
CR 14	8706-100-089	R-CHIP 0805 4,7 KOHM 5%
CR 15	8706-100-089	R-CHIP 0805 4,7 KOHM 5%
CR 16	8706-100-097	R-CHIP 0805 10 KOHM 5%
CR 17	8706-100-097	R-CHIP 0805 10 KOHM 5%
CR 18	8706-100-097	R-CHIP 0805 10 KOHM 5%
CR 19	8706-100-097	R-CHIP 0805 10 KOHM 5%
CR 20	8706-100-127	R-CHIP 0805 180 KOHM 5%
CR 21	8706-100-097	R-CHIP 0805 10 KOHM 5%
CR 22	8706-100-097	R-CHIP 0805 10 KOHM 5%
CR 23	8706-100-097	R-CHIP 0805 10 KOHM 5%
CR 24	8706-100-089	R-CHIP 0805 4,7 KOHM 5%
CR 25	8706-100-089	R-CHIP 0805 4,7 KOHM 5%
CR 26	8706-100-097	R-CHIP 0805 10 KOHM 5%
CR 27	8706-100-097	R-CHIP 0805 10 KOHM 5%
CR 28	8706-100-097	R-CHIP 0805 10 KOHM 5%
CR 29	8706-100-097	R-CHIP 0805 10 KOHM 5%
CR 31	8706-297-000	R-CHIP 1206 0 OHM
CR 32	8706-297-000	R-CHIP 1206 0 OHM
CR 33	8706-297-000	R-CHIP 1206 0 OHM
CR 35	8706-100-073	R-CHIP 0805 1 KOHM 5%
CR 37	8706-100-073	R-CHIP 0805 1 KOHM 5%
CR 41	8706-100-089	R-CHIP 0805 4,7 KOHM 5%
CR 45	8706-100-089	R-CHIP 0805 4,7 KOHM 5%
CR 46	8706-297-000	R-CHIP 1206 0 OHM
CR 47	8706-297-000	R-CHIP 1206 0 OHM
CR 48	8706-297-000	R-CHIP 1206 0 OHM
CR 102	8706-100-093	R-CHIP 0805 6,8 KOHM 5%
CR 103	8706-100-093	R-CHIP 0805 6,8 KOHM 5%
CR 104	8706-100-085	R-CHIP 0805 3,3 KOHM 5%
CR 105	8706-100-109	R-CHIP 0805 33 KOHM 5%
CR 106	8706-100-093	R-CHIP 0805 6,8 KOHM 5%
CR 107	8706-100-091	R-CHIP 0805 5,6 KOHM 5%
CR 108	8706-100-027	R-CHIP 0805 12 OHM 5%
CR 109	8706-100-097	R-CHIP 0805 10 KOHM 5%
CR 112	8706-100-081	R-CHIP 0805 2,2 KOHM 5%
CR 113	8706-100-115	R-CHIP 0805 56 KOHM 5%
CR 114	8706-100-069	R-CHIP 0805 680 OHM 5%
CR 115	8706-100-063	R-CHIP 0805 390 OHM 5%
CR 116	8706-100-065	R-CHIP 0805 470 OHM 5%
CR 117	8706-100-109	R-CHIP 0805 33 KOHM 5%
CR 118	8706-100-091	R-CHIP 0805 5,6 KOHM 5%
CR 119	8706-100-109	R-CHIP 0805 33 KOHM 5%
CR 121	8706-100-073	R-CHIP 0805 1 KOHM 5%
CR 122	8706-100-113	R-CHIP 0805 47 KOHM 5%
CR 123	8706-100-077	R-CHIP 0805 1,5 KOHM 5%
CR 124	8706-100-097	R-CHIP 0805 10 KOHM 5%
CR 125	8706-100-085	R-CHIP 0805 3,3 KOHM 5%
CR 126	8706-100-109	R-CHIP 0805 33 KOHM 5%
CR 127	8706-100-049	R-CHIP 0805 100 OHM 5%
CR 128	8706-100-027	R-CHIP 0805 12 OHM 5%
CR 129	8706-100-097	R-CHIP 0805 10 KOHM 5%
CR 132	8706-100-085	R-CHIP 0805 3,3 KOHM 5%
CR 133	8706-100-081	R-CHIP 0805 2,2 KOHM 5%
CR 134	8706-100-101	R-CHIP 0805 15 KOHM 5%
CR 135	8706-100-069	R-CHIP 0805 680 OHM 5%
CR 136	8706-100-065	R-CHIP 0805 470 OHM 5%
CR 137	8706-100-105	R-CHIP 0805 22 KOHM 5%
CR 201	8706-100-087	R-CHIP 0805 3,9 KOHM 5%
CR 202	8706-100-065	R-CHIP 0805 470 OHM 5%
CR 203	8706-100-131	R-CHIP 0805 270 KOHM 5%
CR 204	8706-100-145	R-CHIP 0805 1 MOHM 5%
CR 205	8706-100-121	R-CHIP 0805 100 KOHM 5%
CR 206	8706-100-071	R-CHIP 0805 820 OHM 5%
CR 207	8706-100-065	R-CHIP 0805 470 OHM 5%
CR 208	8706-100-089	R-CHIP 0805 4,7 KOHM 5%
CR 209	8706-100-089	R-CHIP 0805 4,7 KOHM 5%
CR 211	8706-100-057	R-CHIP 0805 220 OHM 5%
CR 212	8706-100-113	R-CHIP 0805 47 KOHM 5%



ÄNDERUNGEN VORBEHALTEN

POS. NR.	SACHNUMMER	BEZEICHNUNG 
POS. NO.	PART NUMBER	DESCRIPTION 
CR 213	8706-100-121	R-CHIP 0805 100 KOHM 5%
CR 214	8706-100-097	R-CHIP 0805 10 KOHM 5%
CR 215	8706-100-049	R-CHIP 0805 100 OHM 5%
CR 216	8706-100-121	R-CHIP 0805 100 KOHM 5%
CR 217	8706-100-097	R-CHIP 0805 10 KOHM 5%
CR 221	8706-100-121	R-CHIP 0805 100 KOHM 5%
CR 222	8706-100-041	R-CHIP 0805 47 OHM 5%
CR 223	8706-100-041	R-CHIP 0805 47 OHM 5%
CR 224	8706-100-027	R-CHIP 0805 12 OHM 5%
CR 225	8706-100-073	R-CHIP 0805 1 KOHM 5%
CR 226	8706-100-113	R-CHIP 0805 47 KOHM 5%
CR 227	8706-100-073	R-CHIP 0805 1 KOHM 5%
CR 228	8706-100-113	R-CHIP 0805 47 KOHM 5%
CR 229	8706-100-073	R-CHIP 0805 1 KOHM 5%
CR 231	8706-100-113	R-CHIP 0805 47 KOHM 5%
CR 232	8706-100-073	R-CHIP 0805 1 KOHM 5%
CR 233	8706-100-113	R-CHIP 0805 47 KOHM 5%
CR 234	8706-100-073	R-CHIP 0805 1 KOHM 5%
CR 235	8706-100-113	R-CHIP 0805 47 KOHM 5%
CR 236	8706-100-113	R-CHIP 0805 47 KOHM 5%
CR 237	8706-100-073	R-CHIP 0805 1 KOHM 5%
CR 238	8706-100-113	R-CHIP 0805 47 KOHM 5%
CR 239	8706-100-113	R-CHIP 0805 47 KOHM 5%
CR 241	8706-100-073	R-CHIP 0805 1 KOHM 5%
CR 242	8706-100-113	R-CHIP 0805 47 KOHM 5%
CR 243	8706-100-113	R-CHIP 0805 47 KOHM 5%
CR 244	8706-100-073	R-CHIP 0805 1 KOHM 5%
CR 245	8706-100-113	R-CHIP 0805 47 KOHM 5%
CR 246	8706-100-113	R-CHIP 0805 47 KOHM 5%
CR 247	8706-100-081	R-CHIP 0805 2,2 KOHM 5%
CR 248	8706-100-081	R-CHIP 0805 2,2 KOHM 5%
CR 251	8706-100-035	R-CHIP 0805 27 OHM 5%
CR 252	8706-100-059	R-CHIP 0805 270 OHM 5%
CR 253	8706-100-065	R-CHIP 0805 470 OHM 5%
CR 254	8706-100-113	R-CHIP 0805 47 KOHM 5%
CR 256	8706-100-053	R-CHIP 0805 150 OHM 5%
CR 257	8706-100-059	R-CHIP 0805 270 OHM 5%
CR 258	8706-100-065	R-CHIP 0805 470 OHM 5%
CR 259	8706-100-113	R-CHIP 0805 47 KOHM 5%
CR 261	8706-100-057	R-CHIP 0805 220 OHM 5%
CR 262	8706-100-049	R-CHIP 0805 100 OHM 5%
CR 301	8706-100-113	R-CHIP 0805 47 KOHM 5%
CR 302	8706-100-073	R-CHIP 0805 1 KOHM 5%
CR 303	8706-100-121	R-CHIP 0805 100 KOHM 5%
CR 304	8706-100-117	R-CHIP 0805 68 KOHM 5%
CR 305	8706-100-113	R-CHIP 0805 47 KOHM 5%
CR 306	8706-100-073	R-CHIP 0805 1 KOHM 5%
CR 307	8706-100-093	R-CHIP 0805 6,8 KOHM 5%
CR 308	8706-100-071	R-CHIP 0805 820 OHM 5%
CR 309	8706-100-043	R-CHIP 0805 56 OHM 5%
CR 311	8706-100-043	R-CHIP 0805 56 OHM 5%
CR 312	8706-100-067	R-CHIP 0805 560 OHM 5%
CR 313	8706-100-131	R-CHIP 0805 270 KOHM 5%
CR 314	8706-100-075	R-CHIP 0805 1,2 KOHM 5%
CR 315	8706-100-061	R-CHIP 0805 330 OHM 5%
CR 316	8706-100-049	R-CHIP 0805 100 OHM 5%
CR 317	8706-100-049	R-CHIP 0805 100 OHM 5%
CR 318	8706-100-073	R-CHIP 0805 1 KOHM 5%
CR 321	8706-100-053	R-CHIP 0805 150 OHM 5%
CR 322	8706-100-121	R-CHIP 0805 100 KOHM 5%
CR 323	8706-100-087	R-CHIP 0805 3,9 KOHM 5%
CR 324	8706-100-041	R-CHIP 0805 47 OHM 5%
CR 325	8706-100-079	R-CHIP 0805 1,8 KOHM 5%
CR 326	8706-100-097	R-CHIP 0805 10 KOHM 5%
CR 327	8706-100-093	R-CHIP 0805 6,8 KOHM 5%
CR 328	8706-100-121	R-CHIP 0805 100 KOHM 5%
CR 329	8706-100-053	R-CHIP 0805 150 OHM 5%
CR 331	8706-100-081	R-CHIP 0805 2,2 KOHM 5%
CR 402	8706-100-109	R-CHIP 0805 33 KOHM 5%



ALTERNATIONS RESERVED

POS. NR.	SACHNUMMER	BEZEICHNUNG 
POS. NO.	PART NUMBER	DESCRIPTION 
CR 403	8706-100-061	R-CHIP 0805 330 OHM 5%
CR 404	8706-100-057	R-CHIP 0805 220 OHM 5%
CR 405	8706-100-101	R-CHIP 0805 15 KOHM 5%
CR 406	8706-100-107	R-CHIP 0805 27 KOHM 5%
CR 408	8706-100-053	R-CHIP 0805 150 OHM 5%
CR 412	8706-100-077	R-CHIP 0805 1,5 KOHM 5%
CR 413	8706-100-077	R-CHIP 0805 1,5 KOHM 5%
CR 414	8706-100-065	R-CHIP 0805 470 OHM 5%
CR 415	8706-100-103	R-CHIP 0805 18 KOHM 5%
CR 416	8706-100-105	R-CHIP 0805 22 KOHM 5%
CR 417	8706-100-121	R-CHIP 0805 100 KOHM 5%
CR 418	8706-100-121	R-CHIP 0805 100 KOHM 5%
CR 419	8706-100-119	R-CHIP 0805 82 KOHM 5%
CR 421	8706-100-121	R-CHIP 0805 100 KOHM 5%
CR 422	8706-100-103	R-CHIP 0805 18 KOHM 5%
CR 423	8706-100-087	R-CHIP 0805 3,9 KOHM 5%
CR 425	8706-100-119	R-CHIP 0805 82 KOHM 5%
CR 426	8706-100-103	R-CHIP 0805 18 KOHM 5%
CR 427	8706-100-117	R-CHIP 0805 68 KOHM 5%
CR 428	8706-100-105	R-CHIP 0805 22 KOHM 5%
CR 429	8706-100-049	R-CHIP 0805 100 OHM 5%
CR 431	8706-100-073	R-CHIP 0805 1 KOHM 5%
CR 432	8706-100-081	R-CHIP 0805 2,2 KOHM 5%
CR 433	8706-100-081	R-CHIP 0805 2,2 KOHM 5%
CR 434	8706-100-103	R-CHIP 0805 18 KOHM 5%
CR 435	8706-100-097	R-CHIP 0805 10 KOHM 5%
CR 436	8706-100-059	R-CHIP 0805 270 OHM 5%
CR 437	8706-100-079	R-CHIP 0805 1,8 KOHM 5%
CR 438	8706-100-071	R-CHIP 0805 820 OHM 5%
CR 439	8706-100-079	R-CHIP 0805 1,8 KOHM 5%
CR 441	8706-100-121	R-CHIP 0805 100 KOHM 5%
CR 442	8706-100-049	R-CHIP 0805 100 OHM 5%
CR 443	8706-100-085	R-CHIP 0805 3,3 KOHM 5%
CR 444	8706-100-049	R-CHIP 0805 100 OHM 5%
CR 445	8706-100-097	R-CHIP 0805 10 KOHM 5%
CR 446	8706-100-097	R-CHIP 0805 10 KOHM 5%
CR 447	8706-100-121	R-CHIP 0805 100 KOHM 5%
CR 451	8706-100-115	R-CHIP 0805 56 KOHM 5%
CR 453	8706-100-065	R-CHIP 0805 470 OHM 5%
CR 503	8706-100-035	R-CHIP 0805 27 OHM 5%
CR 504	8706-100-097	R-CHIP 0805 10 KOHM 5%
CR 505	8706-100-097	R-CHIP 0805 10 KOHM 5%
CR 506	8706-100-117	R-CHIP 0805 68 KOHM 5%
CR 507	8706-100-073	R-CHIP 0805 1 KOHM 5%
CR 509	8706-100-067	R-CHIP 0805 560 OHM 5%
CR 511	8706-100-105	R-CHIP 0805 22 KOHM 5%
CR 513	8706-100-097	R-CHIP 0805 10 KOHM 5%
CR 514	8706-100-097	R-CHIP 0805 10 KOHM 5%
CR 515	8706-100-073	R-CHIP 0805 1 KOHM 5%
CR 516	8706-100-073	R-CHIP 0805 1 KOHM 5%
CR 517	8706-100-091	R-CHIP 0805 5,6 KOHM 5%
CR 518	8706-100-121	R-CHIP 0805 100 KOHM 5%
CR 519	8706-100-065	R-CHIP 0805 470 OHM 5%
CR 521	8706-100-067	R-CHIP 0805 560 OHM 5%
CR 522	8706-100-097	R-CHIP 0805 10 KOHM 5%
CR 523	8706-100-027	R-CHIP 0805 12 OHM 5%
CR 524	8706-100-121	R-CHIP 0805 100 KOHM 5%
CR 525	8706-100-127	R-CHIP 0805 180 KOHM 5%
CR 526	8706-100-121	R-CHIP 0805 100 KOHM 5%
CR 527	8706-100-091	R-CHIP 0805 5,6 KOHM 5%
CR 528	8706-100-121	R-CHIP 0805 100 KOHM 5%
CR 529	8706-100-107	R-CHIP 0805 27 KOHM 5%
CR 532	8706-100-093	R-CHIP 0805 6,8 KOHM 5%
CR 534	8706-100-145	R-CHIP 0805 1 MOHM 5%
CR 535	8706-100-119	R-CHIP 0805 82 KOHM 5%
CR 536	8706-100-085	R-CHIP 0805 3,3 KOHM 5%
CR 538	8706-100-081	R-CHIP 0805 2,2 KOHM 5%
CR 602	8706-100-097	R-CHIP 0805 10 KOHM 5%
CR 604	8706-100-073	R-CHIP 0805 1 KOHM 5%



ÄNDERUNGEN VORBEHALTEN

POS. NR.	SACHNUMMER	BEZEICHNUNG 
POS. NO.	PART NUMBER	DESCRIPTION 
CR 606	8706-100-089	R-CHIP 0805 4,7 KOHM 5%
CR 607	8706-100-121	R-CHIP 0805 100 KOHM 5%
CR 609	8706-100-105	R-CHIP 0805 22 KOHM 5%
CR 611	8706-100-125	R-CHIP 0805 150 KOHM 5%
CR 612	8706-100-109	R-CHIP 0805 33 KOHM 5%
CR 613	8706-297-000	R-CHIP 1206 0 OHM
CR 614	8706-100-113	R-CHIP 0805 47 KOHM 5%
CR 616	8706-100-129	R-CHIP 0805 220 KOHM 5%
CR 617	8706-100-097	R-CHIP 0805 10 KOHM 5%
CR 618	8706-100-097	R-CHIP 0805 10 KOHM 5%
CR 621	8706-100-085	R-CHIP 0805 3,3 KOHM 5%
CR 622	8706-100-073	R-CHIP 0805 1 KOHM 5%
CR 623	8706-100-081	R-CHIP 0805 2,2 KOHM 5%
CR 624	8706-100-121	R-CHIP 0805 100 KOHM 5%
CR 625	8706-100-145	R-CHIP 0805 1 MOHM 5%
CR 626	8706-100-073	R-CHIP 0805 1 KOHM 5%
CR 629	8706-100-087	R-CHIP 0805 3,9 KOHM 5%
CR 631	8706-100-103	R-CHIP 0805 18 KOHM 5%
CR 632	8706-100-109	R-CHIP 0805 33 KOHM 5%
CR 633	8706-100-109	R-CHIP 0805 33 KOHM 5%
CR 634	8706-100-131	R-CHIP 0805 270 KOHM 5%
CR 636	8706-100-141	R-CHIP 0805 680 KOHM 5%
CR 637	8706-100-075	R-CHIP 0805 1,2 KOHM 5%
CR 638	8706-100-085	R-CHIP 0805 3,3 KOHM 5%
CR 642	8706-100-085	R-CHIP 0805 3,3 KOHM 5%
CR 643	8706-100-097	R-CHIP 0805 10 KOHM 5%
CR 644	8706-100-129	R-CHIP 0805 220 KOHM 5%
CR 645	8706-100-133	R-CHIP 0805 330 KOHM 5%
CR 646	8706-100-105	R-CHIP 0805 22 KOHM 5%
CR 647	8706-100-081	R-CHIP 0805 2,2 KOHM 5%
CR 649	8706-100-089	R-CHIP 0805 4,7 KOHM 5%
CR 652	8706-100-087	R-CHIP 0805 3,9 KOHM 5%
CR 653	8706-100-099	R-CHIP 0805 12 KOHM 5%
CR 654	8706-100-113	R-CHIP 0805 47 KOHM 5%
CR 655	8706-100-075	R-CHIP 0805 1,2 KOHM 5%
CR 657	8706-297-000	R-CHIP 1206 0 OHM
CR 661	8706-100-131	R-CHIP 0805 270 KOHM 5%
CR 662	8706-100-051	R-CHIP 0805 120 OHM 5%
CR 663	8706-100-047	R-CHIP 0805 82 OHM 5%
CR 665	8706-100-073	R-CHIP 0805 1 KOHM 5%
CR 666	8706-100-075	R-CHIP 0805 1,2 KOHM 5%
CR 667	8706-100-041	R-CHIP 0805 47 OHM 5%
CR 671	8706-297-000	R-CHIP 1206 0 OHM
CR 721	8706-100-085	R-CHIP 0805 3,3 KOHM 5%
CR 722	8706-100-073	R-CHIP 0805 1 KOHM 5%
CR 723	8706-100-081	R-CHIP 0805 2,2 KOHM 5%
CR 724	8706-100-121	R-CHIP 0805 100 KOHM 5%
CR 725	8706-100-145	R-CHIP 0805 1 MOHM 5%
CR 726	8706-100-073	R-CHIP 0805 1 KOHM 5%
CR 727	8706-100-131	R-CHIP 0805 270 KOHM 5%
CR 729	8706-100-087	R-CHIP 0805 3,9 KOHM 5%
CR 731	8706-100-103	R-CHIP 0805 18 KOHM 5%
CR 732	8706-100-109	R-CHIP 0805 33 KOHM 5%
CR 733	8706-100-109	R-CHIP 0805 33 KOHM 5%
CR 734	8706-100-131	R-CHIP 0805 270 KOHM 5%
CR 736	8706-100-141	R-CHIP 0805 680 KOHM 5%
CR 737	8706-100-075	R-CHIP 0805 1,2 KOHM 5%
CR 738	8706-100-085	R-CHIP 0805 3,3 KOHM 5%
CR 742	8706-100-085	R-CHIP 0805 3,3 KOHM 5%
CR 743	8706-100-097	R-CHIP 0805 10 KOHM 5%
CR 744	8706-100-129	R-CHIP 0805 220 KOHM 5%
CR 745	8706-100-133	R-CHIP 0805 330 KOHM 5%
CR 746	8706-100-105	R-CHIP 0805 22 KOHM 5%
CR 747	8706-100-081	R-CHIP 0805 2,2 KOHM 5%
CR 749	8706-100-089	R-CHIP 0805 4,7 KOHM 5%
CR 752	8706-100-087	R-CHIP 0805 3,9 KOHM 5%
CR 753	8706-100-099	R-CHIP 0805 12 KOHM 5%
CR 754	8706-100-113	R-CHIP 0805 47 KOHM 5%
CR 755	8706-100-075	R-CHIP 0805 1,2 KOHM 5%



ALTERNATIONS RESERVED

POS. NR.	SACHNUMMER	BEZEICHNUNG 
POS. NO.	PART NUMBER	DESCRIPTION 
CR 761	8706-100-131	R-CHIP 0805 270 KOHM 5%
CR 762	8706-100-051	R-CHIP 0805 120 OHM 5%
CR 763	8706-100-047	R-CHIP 0805 82 OHM 5%
CR 765	8706-100-073	R-CHIP 0805 1 KOHM 5%
CR 767	8706-100-041	R-CHIP 0805 47 OHM 5%
CR 768	8706-297-000	R-CHIP 1206 0 OHM
CR 769	8706-297-000	R-CHIP 1206 0 OHM
CR 771	8706-297-000	R-CHIP 1206 0 OHM
CR 772	8706-297-000	R-CHIP 1206 0 OHM
CR 801	8706-100-065	R-CHIP 0805 470 OHM 5%
CR 802	8706-100-117	R-CHIP 0805 68 KOHM 5%
CR 803	8706-100-073	R-CHIP 0805 1 KOHM 5%
CR 804	8706-100-085	R-CHIP 0805 3,3 KOHM 5%
CR 805	8706-100-097	R-CHIP 0805 10 KOHM 5%
CR 806	8706-100-093	R-CHIP 0805 6,8 KOHM 5%
CR 807	8706-100-117	R-CHIP 0805 68 KOHM 5%
CR 808	8706-100-085	R-CHIP 0805 3,3 KOHM 5%
CR 809	8706-100-085	R-CHIP 0805 3,3 KOHM 5%
CR 811	8706-100-081	R-CHIP 0805 2,2 KOHM 5%
CR 814	8706-100-113	R-CHIP 0805 47 KOHM 5%
CR 815	8706-100-113	R-CHIP 0805 47 KOHM 5%
CR 816	8706-100-081	R-CHIP 0805 2,2 KOHM 5%
CR 818	8706-100-073	R-CHIP 0805 1 KOHM 5%
CR 819	8706-100-089	R-CHIP 0805 4,7 KOHM 5%
CR 821	8706-100-121	R-CHIP 0805 100 KOHM 5%
CR 822	8706-100-085	R-CHIP 0805 3,3 KOHM 5%
CR 823	8706-100-127	R-CHIP 0805 180 KOHM 5%
CR 824	8706-100-073	R-CHIP 0805 1 KOHM 5%
CR 825	8706-100-131	R-CHIP 0805 270 KOHM 5%
CR 826	8706-100-145	R-CHIP 0805 1 MOHM 5%
CR 827	8706-100-065	R-CHIP 0805 470 OHM 5%
CR 828	8706-100-049	R-CHIP 0805 100 OHM 5%
CR 829	8706-100-073	R-CHIP 0805 1 KOHM 5%
CR 831	8706-100-117	R-CHIP 0805 68 KOHM 5%
CR 832	8706-100-109	R-CHIP 0805 33 KOHM 5%
CR 833	8706-100-109	R-CHIP 0805 33 KOHM 5%
CR 834	8706-100-109	R-CHIP 0805 33 KOHM 5%
CR 835	8706-100-089	R-CHIP 0805 4,7 KOHM 5%
CR 836	8706-100-121	R-CHIP 0805 100 KOHM 5%
CR 837	8706-100-085	R-CHIP 0805 3,3 KOHM 5%
CR 838	8706-100-115	R-CHIP 0805 56 KOHM 5%
CR 839	8706-100-073	R-CHIP 0805 1 KOHM 5%
CR 841	8706-100-113	R-CHIP 0805 47 KOHM 5%
CR 842	8706-100-145	R-CHIP 0805 1 MOHM 5%
CR 843	8706-100-049	R-CHIP 0805 100 OHM 5%
CR 844	8706-100-065	R-CHIP 0805 470 OHM 5%
CR 845	8706-100-121	R-CHIP 0805 100 KOHM 5%
CR 846	8706-100-121	R-CHIP 0805 100 KOHM 5%
CR 847	8706-100-113	R-CHIP 0805 47 KOHM 5%
CR 848	8706-100-133	R-CHIP 0805 330 KOHM 5%
CR 849	8706-100-101	R-CHIP 0805 15 KOHM 5%
CR 851	8706-100-085	R-CHIP 0805 3,3 KOHM 5%
CR 853	8706-100-121	R-CHIP 0805 100 KOHM 5%
CR 854	8706-100-113	R-CHIP 0805 47 KOHM 5%
CR 855	8706-100-089	R-CHIP 0805 4,7 KOHM 5%
CR 856	8706-100-057	R-CHIP 0805 220 OHM 5%
CR 857	8706-100-097	R-CHIP 0805 10 KOHM 5%
CR 858	8706-100-121	R-CHIP 0805 100 KOHM 5%
CR 859	8706-100-113	R-CHIP 0805 47 KOHM 5%
CR 862	8706-100-109	R-CHIP 0805 33 KOHM 5%
CR 863	8706-100-133	R-CHIP 0805 330 KOHM 5%
CR 864	8706-100-073	R-CHIP 0805 1 KOHM 5%
CR 865	8706-100-097	R-CHIP 0805 10 KOHM 5%
CR 866	8706-100-129	R-CHIP 0805 220 KOHM 5%
CR 901	8706-100-065	R-CHIP 0805 470 OHM 5%
CR 904	8706-100-131	R-CHIP 0805 270 KOHM 5%
CR 906	8706-100-117	R-CHIP 0805 68 KOHM 5%
CR 908	8706-100-121	R-CHIP 0805 100 KOHM 5%
CR 909	8706-100-097	R-CHIP 0805 10 KOHM 5%





ÄNDERUNGEN VORBEHALTEN

POS. NR.	SACHNUMMER	BEZEICHNUNG 
POS. NO.	PART NUMBER	DESCRIPTION 
CR 911	8706-100-097	R-CHIP 0805 10 KOHM 5%
CR 912	8706-100-097	R-CHIP 0805 10 KOHM 5%
CR 914	8706-100-081	R-CHIP 0805 2,2 KOHM 5%
CR 915	8706-100-073	R-CHIP 0805 1 KOHM 5%
CR 916	8706-100-097	R-CHIP 0805 10 KOHM 5%
CR 917	8706-100-073	R-CHIP 0805 1 KOHM 5%
CR 918	8706-100-089	R-CHIP 0805 4,7 KOHM 5%
CR 919	8706-100-063	R-CHIP 0805 390 OHM 5%
CR 921	8706-297-000	R-CHIP 1206 0 OHM
CR 951	8706-100-121	R-CHIP 0805 100 KOHM 5%
CR 952	8706-100-089	R-CHIP 0805 4,7 KOHM 5%
CR 953	8706-100-041	R-CHIP 0805 47 OHM 5%
CR 954	8706-100-001	R-CHIP 0805 1 OHM 5%
CR 955	8706-100-087	R-CHIP 0805 3,9 KOHM 5%
CR 956	8706-100-049	R-CHIP 0805 100 OHM 5%
CR 1001	8706-100-073	R-CHIP 0805 1 KOHM 5%
CR 1002	8706-100-125	R-CHIP 0805 150 KOHM 5%
CR 1003	8706-100-133	R-CHIP 0805 330 KOHM 5%
CR 1004	8706-100-097	R-CHIP 0805 10 KOHM 5%
CR 1005	8706-100-027	R-CHIP 0805 12 OHM 5%
CR 1006	8706-100-103	R-CHIP 0805 18 KOHM 5%
CR 1007	8706-100-089	R-CHIP 0805 4,7 KOHM 5%
CR 1008	8706-100-103	R-CHIP 0805 18 KOHM 5%
CR 1009	8706-100-103	R-CHIP 0805 18 KOHM 5%
CR 1012	8706-100-129	R-CHIP 0805 220 KOHM 5%
CR 1013	8706-100-081	R-CHIP 0805 2,2 KOHM 5%
CR 1014	8706-100-133	R-CHIP 0805 330 KOHM 5%
CR 1015	8706-100-125	R-CHIP 0805 150 KOHM 5%
CR 1016	8706-100-133	R-CHIP 0805 330 KOHM 5%
CR 1017	8706-100-125	R-CHIP 0805 150 KOHM 5%
CR 1018	8706-100-075	R-CHIP 0805 1,2 KOHM 5%
CR 1102	8706-100-073	R-CHIP 0805 1 KOHM 5%
CR 1103	8706-100-097	R-CHIP 0805 10 KOHM 5%
CR 1104	8706-100-131	R-CHIP 0805 270 KOHM 5%
CR 1105	8706-100-097	R-CHIP 0805 10 KOHM 5%
CR 1106	8706-100-025	R-CHIP 0805 10 OHM 5%
CR 1107	8706-100-075	R-CHIP 0805 1,2 KOHM 5%
CR 1108	8706-100-083	R-CHIP 0805 2,7 KOHM 5%
CR 1109	8706-100-117	R-CHIP 0805 68 KOHM 5%
CR 1111	8706-100-131	R-CHIP 0805 270 KOHM 5%
CR 1112	8706-100-113	R-CHIP 0805 47 KOHM 5%
CR 1113	8706-100-109	R-CHIP 0805 33 KOHM 5%
CR 1114	8706-100-081	R-CHIP 0805 2,2 KOHM 5%
CR 1115	8706-100-121	R-CHIP 0805 100 KOHM 5%
CR 1116	8706-100-089	R-CHIP 0805 4,7 KOHM 5%
CR 1118	8706-100-325	R-CHIP 0805 150 KOHM 2%
CR 1119	8706-100-057	R-CHIP 0805 220 OHM 5%
CR 1121	8706-100-083	R-CHIP 0805 2,7 KOHM 5%
CR 1122	8706-100-117	R-CHIP 0805 68 KOHM 5%
CR 1123	8706-100-131	R-CHIP 0805 270 KOHM 5%
CR 1124	8706-100-113	R-CHIP 0805 47 KOHM 5%
CR 1125	8706-100-121	R-CHIP 0805 100 KOHM 5%
CR 1126	8706-100-129	R-CHIP 0805 220 KOHM 5%
CR 1127	8706-100-097	R-CHIP 0805 10 KOHM 5%
CR 1128	8706-100-089	R-CHIP 0805 4,7 KOHM 5%
CR 1129	8706-100-121	R-CHIP 0805 100 KOHM 5%
CR 1131	8706-100-129	R-CHIP 0805 220 KOHM 5%
CR 1132	8706-100-135	R-CHIP 0805 390 KOHM 5%
CR 1134	8706-100-115	R-CHIP 0805 56 KOHM 5%
CR 1136	8706-100-113	R-CHIP 0805 47 KOHM 5%
CR 1137	8706-100-115	R-CHIP 0805 56 KOHM 5%
CR 1142	8706-100-121	R-CHIP 0805 100 KOHM 5%
CR 1143	8706-100-121	R-CHIP 0805 100 KOHM 5%
CR 1144	8706-100-121	R-CHIP 0805 100 KOHM 5%
CR 1145	8706-100-121	R-CHIP 0805 100 KOHM 5%
CR 1146	8706-100-121	R-CHIP 0805 100 KOHM 5%
CR 1147	8706-100-121	R-CHIP 0805 100 KOHM 5%
CR 1148	8706-100-121	R-CHIP 0805 100 KOHM 5%
CR 1149	8706-100-121	R-CHIP 0805 100 KOHM 5%





ALTERNATIONS RESERVED

POS. NR.	SACHNUMMER	BEZEICHNUNG 
POS. NO.	PART NUMBER	DESCRIPTION 
CR 1151	8706-100-097	R-CHIP 0805 10 KOHM 5%
CR 1152	8706-100-097	R-CHIP 0805 10 KOHM 5%
CR 1153	8706-100-097	R-CHIP 0805 10 KOHM 5%
CR 1154	8706-100-097	R-CHIP 0805 10 KOHM 5%
CR 1155	8706-100-097	R-CHIP 0805 10 KOHM 5%
CR 1156	8706-100-121	R-CHIP 0805 100 KOHM 5%
CR 1161	8706-100-121	R-CHIP 0805 100 KOHM 5%
CR 1162	8706-100-073	R-CHIP 0805 1 KOHM 5%
CR 1163	8706-100-073	R-CHIP 0805 1 KOHM 5%
CR 1164	8706-100-097	R-CHIP 0805 10 KOHM 5%
CR 1165	8706-100-097	R-CHIP 0805 10 KOHM 5%
CR 1166	8706-100-089	R-CHIP 0805 4,7 KOHM 5%
CR 1167	8706-100-089	R-CHIP 0805 4,7 KOHM 5%
CR 1168	8706-100-133	R-CHIP 0805 330 KOHM 5%
CR 1169	8706-100-089	R-CHIP 0805 4,7 KOHM 5%
CR 1171	8706-100-089	R-CHIP 0805 4,7 KOHM 5%
CR 1172	8706-100-089	R-CHIP 0805 4,7 KOHM 5%
CR 1173	8706-100-073	R-CHIP 0805 1 KOHM 5%
CR 1174	8706-100-089	R-CHIP 0805 4,7 KOHM 5%
CR 1175	8706-100-121	R-CHIP 0805 100 KOHM 5%
CR 1176	8706-100-121	R-CHIP 0805 100 KOHM 5%
CR 1177	8706-100-089	R-CHIP 0805 4,7 KOHM 5%
CR 1178	8706-100-089	R-CHIP 0805 4,7 KOHM 5%
CR 1179	8706-100-097	R-CHIP 0805 10 KOHM 5%
CR 1181	8706-100-097	R-CHIP 0805 10 KOHM 5%
CR 1182	8706-100-121	R-CHIP 0805 100 KOHM 5%
CR 1183	8706-100-073	R-CHIP 0805 1 KOHM 5%
CR 1184	8706-100-113	R-CHIP 0805 47 KOHM 5%
CR 1185	8706-100-121	R-CHIP 0805 100 KOHM 5%
CR 1186	8706-100-121	R-CHIP 0805 100 KOHM 5%
CR 1187	8706-100-073	R-CHIP 0805 1 KOHM 5%
CR 1188	8706-100-117	R-CHIP 0805 68 KOHM 5%
CR 1189	8706-100-117	R-CHIP 0805 68 KOHM 5%
CR 1191	8706-100-117	R-CHIP 0805 68 KOHM 5%
CR 1192	8706-100-117	R-CHIP 0805 68 KOHM 5%
CR 1193	8706-100-117	R-CHIP 0805 68 KOHM 5%
CR 1194	8706-100-117	R-CHIP 0805 68 KOHM 5%
CR 1195	8706-100-117	R-CHIP 0805 68 KOHM 5%
CR 1196	8706-100-117	R-CHIP 0805 68 KOHM 5%
CR 1197	8706-100-083	R-CHIP 0805 2,7 KOHM 5%
CR 1198	8706-100-073	R-CHIP 0805 1 KOHM 5%
CR 1199	8706-100-093	R-CHIP 0805 6,8 KOHM 5%
		
CT 11	8301-006-848	SMD-TRANS.BC 848 C
CT 12	8301-006-848	SMD-TRANS.BC 848 C
CT 101	8301-006-848	SMD-TRANS.BC 848 C
CT 102	8301-130-543	SMD-TRANS.BF 543 E 7810
CT 103	8301-130-840	SMD-TRANS.BF 840
CT 104	8301-130-543	SMD-TRANS.BF 543 E 7810
CT 105	8301-006-848	SMD-TRANS.BC 848 C
CT 106	8301-130-543	SMD-TRANS.BF 543 E 7810
CT 107	8301-130-840	SMD-TRANS.BF 840
CT 201	8301-006-858	SMD-TRANS.BC 858 C
CT 202	8301-006-858	SMD-TRANS.BC 858 C
CT 203	8301-006-858	SMD-TRANS.BC 858 C
CT 204	8301-130-992	SMD-TRANS.BF 992 A
CT 205	8301-130-550	SMD-TRANS.BF 550
CT 206	8301-130-543	SMD-TRANS.BF 543 E 7810
CT 207	8301-130-543	SMD-TRANS.BF 543 E 7810
CT 301	8301-130-999	SMD-TRANS.BF 999 E7727
CT 302	8301-130-550	SMD-TRANS.BF 550
CT 303	8301-130-840	SMD-TRANS.BF 840
CT 304	8301-130-543	SMD-TRANS.BF 543 E 7810
CT 305	8301-130-550	SMD-TRANS.BF 550
CT 306	8301-130-543	SMD-TRANS.BF 543 E 7810
CT 401	8301-130-550	SMD-TRANS.BF 550





ÄNDERUNGEN VORBEHALTEN

POS. NR.	SACHNUMMER	BEZEICHNUNG 
POS. NO.	PART NUMBER	DESCRIPTION 
CT 402	8301-130-543	SMD-TRANS.BF 543 E 7810
CT 403	8301-130-543	SMD-TRANS.BF 543 E 7810
CT 404	8301-130-840	SMD-TRANS.BF 840
CT 405	8301-006-848	SMD-TRANS.BC 848 C
CT 406	8301-130-992	SMD-TRANS.BF 992 A
CT 407	8301-130-992	SMD-TRANS.BF 992 A
CT 408	8301-130-840	SMD-TRANS.BF 840
CT 409	8301-130-840	SMD-TRANS.BF 840
CT 411	8301-130-840	SMD-TRANS.BF 840
CT 412	8301-006-848	SMD-TRANS.BC 848 C
CT 413	8301-130-840	SMD-TRANS.BF 840
CT 501	8301-006-858	SMD-TRANS.BC 858 C
CT 502	8301-006-848	SMD-TRANS.BC 848 C
CT 503	8301-006-848	SMD-TRANS.BC 848 C
CT 601	8301-004-848	SMD-TRANS.BC 848 B
CT 603	8301-006-848	SMD-TRANS.BC 848 C
CT 604	8301-006-848	SMD-TRANS.BC 848 C
CT 605	8301-006-849	SMD-TRANS.BC 849 C
CT 606	8301-006-859	SMD-TRANS.BC 859 C
CT 607	8301-006-848	SMD-TRANS.BC 848 C
CT 608	8301-006-848	SMD-TRANS.BC 848 C
CT 704	8301-006-848	SMD-TRANS.BC 848 C
CT 705	8301-006-849	SMD-TRANS.BC 849 C
CT 706	8301-006-859	SMD-TRANS.BC 859 C
CT 707	8301-006-848	SMD-TRANS.BC 848 C
CT 708	8301-006-848	SMD-TRANS.BC 848 C
CT 801	8301-006-848	SMD-TRANS.BC 848 C
CT 802	8301-006-848	SMD-TRANS.BC 848 C
CT 803	8301-006-848	SMD-TRANS.BC 848 C
CT 804	8301-006-848	SMD-TRANS.BC 848 C
CT 805	8301-130-543	SMD-TRANS.BF 543 E 7810
CT 806	8301-006-848	SMD-TRANS.BC 848 C
CT 807	8301-130-543	SMD-TRANS.BF 543 E 7810
CT 808	8301-006-848	SMD-TRANS.BC 848 C
CT 809	8301-006-848	SMD-TRANS.BC 848 C
CT 811	8301-006-848	SMD-TRANS.BC 848 C
CT 902	8301-006-848	SMD-TRANS.BC 848 C
CT 904	8301-002-858	SMD-TRANS.BC 858 A
CT 905	8301-006-858	SMD-TRANS.BC 858 C
CT 906	8301-002-858	SMD-TRANS.BC 858 A
CT 908	8301-006-848	SMD-TRANS.BC 848 C
CT 909	8301-006-848	SMD-TRANS.BC 848 C
CT 911	8301-006-848	SMD-TRANS.BC 848 C
CT 912	8301-006-848	SMD-TRANS.BC 848 C
CT 1001	8301-006-858	SMD-TRANS.BC 858 C
CT 1102	8301-006-858	SMD-TRANS.BC 858 C
CT 1103	8301-006-848	SMD-TRANS.BC 848 C
CT 1104	8301-006-858	SMD-TRANS.BC 858 C
CT 1105	8301-006-848	SMD-TRANS.BC 848 C
CT 1107	 8301-006-858	SMD-TRANS.BC 858 C
CT 1108	8301-006-848	SMD-TRANS.BC 848 C
CT 1109	8301-006-848	SMD-TRANS.BC 848 C
CT 1111	8301-006-848	SMD-TRANS.BC 848 C
CT 1112	8301-006-848	SMD-TRANS.BC 848 C
CT 1113	8301-006-848	SMD-TRANS.BC 848 C
CT 1114	8301-006-848	SMD-TRANS.BC 848 C
CT 1115	8301-006-848	SMD-TRANS.BC 848 C
CT 1116	8301-006-848	SMD-TRANS.BC 848 C
CT 1117	8301-006-848	SMD-TRANS.BC 848 C
CT 1118	8301-006-848	SMD-TRANS.BC 848 C
CT 1121	8301-006-858	SMD-TRANS.BC 858 C
CT 1122	8301-006-858	SMD-TRANS.BC 858 C
CT 1123	8301-006-858	SMD-TRANS.BC 858 C
		
CD 101	8309-430-619	KAP.PLAST DIODE BB 619
CD 401	8309-325-620	CHIP KAP DIODE BB 620
CD 402	8309-210-016	SMD-DIODE BAS 16 PHI
CD 801	8309-430-619	KAP.PLAST DIODE BB 619





ALTERNATIONS RESERVED







POS. NR.	SACHNUMMER	BEZEICHNUNG 
POS. NO.	PART NUMBER	DESCRIPTION 
		
D 11	8309-215-043	DIODE 1 N 4151 PHI/TFK/
D 12	8309-215-043	DIODE 1 N 4151 PHI/TFK/
D 13	8309-215-043	DIODE 1 N 4151 PHI/TFK/
D 14	8309-215-043	DIODE 1 N 4151 PHI/TFK/
D 15	8309-198-042	DIODE BAT 42 THO
D 102	8309-215-043	DIODE 1 N 4151 PHI/TFK/
D 103	8309-215-043	DIODE 1 N 4151 PHI/TFK/
D 203	8309-215-043	DIODE 1 N 4151 PHI/TFK/
D 204	8309-215-043	DIODE 1 N 4151 PHI/TFK/
D 205	8309-201-480	DIODE BA 479 S
D 208	8309-201-026	DIODE BA 243
D 209	8309-201-480	DIODE BA 479 S
D 213	8309-201-026	DIODE BA 243
D 214	8309-201-026	DIODE BA 243
D 217	8309-201-026	DIODE BA 243
D 218	8309-201-026	DIODE BA 243
D 222	8309-201-026	DIODE BA 243
D 223	8309-201-026	DIODE BA 243
D 224	8309-201-026	DIODE BA 243
D 301	8309-510-254	DIODE BB 204 GRUEN SIE/
D 302	8309-510-254	DIODE BB 204 GRUEN SIE/
D 303	8309-510-254	DIODE BB 204 GRUEN SIE/
D 304	8309-215-043	DIODE 1 N 4151 PHI/TFK/
D 305	8309-215-043	DIODE 1 N 4151 PHI/TFK/
D 306	8309-215-043	DIODE 1 N 4151 PHI/TFK/
D 307	8309-215-043	DIODE 1 N 4151 PHI/TFK/
D 308	8309-510-252	DIODE BB 204 BLAU SIE/
D 309	8309-201-026	DIODE BA 243
D 501	8309-215-043	DIODE 1 N 4151 PHI/TFK/
D 502	8309-215-043	DIODE 1 N 4151 PHI/TFK/
D 503	8309-198-081	DIODE BAT 81
D 504	8309-198-081	DIODE BAT 81
D 505	8309-215-043	DIODE 1 N 4151 PHI/TFK/
D 601	8309-215-043	DIODE 1 N 4151 PHI/TFK/
D 602	8309-940-002	LE DIODE LT 8001 P SHARP
D 603	8309-215-043	DIODE 1 N 4151 PHI/TFK/
D 604	8309-215-043	DIODE 1 N 4151 PHI/TFK/
D 605	8309-215-043	DIODE 1 N 4151 PHI/TFK/
D 802	8309-215-043	DIODE 1 N 4151 PHI/TFK/
D 803	8309-215-043	DIODE 1 N 4151 PHI/TFK/
D 901	8309-940-002	LE DIODE LT 8001 P SHARP
D 902	8309-215-006	DIODE 1 N 4001 -GA
D 903	8309-518-130	DIODE SB 130 GI WW.
D 904	8309-215-006	DIODE 1 N 4001 -GA
D 905	8309-215-043	DIODE 1 N 4151 PHI/TFK/
D 906	8309-720-046	Z DIODE 4,7 B 0,5W
D 911	8309-200-018	DIODE BAV 19 VAL
D 912	8309-701-230	Z DIODE BZX 55 B30 TFK
D 1101	8309-720-051	Z DIODE 5,1 B 0,5W
D 1102	8309-198-042	DIODE BAT 42 THO
D 1103	8309-198-042	DIODE BAT 42 THO
D 1104	8309-198-042	DIODE BAT 42 THO
D 1105	8309-198-042	DIODE BAT 42 THO
D 1106	8309-198-042	DIODE BAT 42 THO
D 201/2	8309-510-130	DIODE BB 130
D 206/2	8309-510-130	DIODE BB 130
D 211/2	8309-510-130	DIODE BB 130
D 215/2	8309-510-130	DIODE BB 130
D 219/2	8309-510-130	DIODE BB 130
		
F 1	07202-346.97	FILTER 7X7
F 2	19203-121.14	KERAMIK-FILTER-SATZ

ÄNDERUNGEN VORBEHALTEN

POS. NR.	SACHNUMMER	BEZEICHNUNG 
POS. NO.	PART NUMBER	DESCRIPTION 
F 3	19203-121.14	KERAMIK-FILTER-SATZ
F 4	19203-121.14	KERAMIK-FILTER-SATZ
F 5	19202-701.97	SPULE 10X10
F 6	8382-251-497	QUARZFILTER 54,5 MHZ
F 7	07202-635.97	FILTER 7X7
F 8	19203-113.14	KERAMIK-FILTER SFR 450 H
F 9	19203-102.14	KERAMIK-FILTER SFR 450 J
F 10	19203-121.14	KERAMIK-FILTER-SATZ
F 11	8602-331-084	KER.RES.84 3,6 MGF 104
F 12	07202-713.10	SPULE 7X7
		
IC 11	8305-275-725	IC UPD 7225 G-00 NEC
IC 21	8305-275-725	IC UPD 7225 G-00 NEC
IC 101	8305-258-161	IC CX 7961 A SONY
IC 102	8305-274-037	IC UPC 1037 HA NEC
IC 103	8305-258-162	IC CX 7961 A-1 SONY
IC 104	8305-274-037	IC UPC 1037 HA NEC
IC 501	8305-260-155	IC LA 1205 SANYO
IC 502	8305-204-393	IC LM 393P TID/393N RAY/
IC 601	8305-260-331	IC LA 3361 SANYO
IC 602	8305-302-036	IC TBA 820 M
IC 702	8305-302-036	IC TBA 820 M
IC 802	8305-205-067	MC 14066BCP MOT/HCF 4066
IC 1002	8305-204-393	IC LM 393P TID/393N RAY/
IC 1101	8305-275-316	IC UPD 75516
IC 1102	8305-204-357	IC LM 358 N NSC/TID/MOT/
IC 1103	8305-268-295	IC LP 2951 AC (N)
IC 1104	8305-602-416	IC X 24 C 16-P3
		
L 11	8140-526-099	DR AX 0309-GA 1MH
L 21	8140-526-099	DR AX 0309-GA 1MH
L 103	8140-526-421	DR AX 0411-GA 2,7UH
L 104	07202-726.97	SPULE
L 108	8140-526-431	DR AX 0411-GA 0,33UH
L 109	07202-640.97	SPULE 7X7
L 204	8140-525-915	DR AX 0411-GA 1MH
L 205	8140-526-329	DR AX 0411-GA 150UH
L 206	8140-525-884	DR AX 0411-GA 68UH
L 211	8140-526-400	DR AX 0411-GA 100UH
L 301	8140-526-430	DR AX 0411-GA 0,22UH
L 302	8140-530-250	UKW-SPULE 4/75
L 304	8140-530-264	UKW-SPULE 3/34
L 305	8140-530-264	UKW-SPULE 3/34
L 307	8140-525-950	DR AX 0411-GA 27UH
L 308	8140-530-266	UKW-SPULE 3/32
L 401	8140-526-401	DR AX 0411-GA 6,8UH
L 402	8140-526-430	DR AX 0411-GA 0,22UH
L 404	19202-706.97	RINGKERNUEBERTRAGER
L 405	8140-526-419	DR AX 0411-GA 1UH
L 406	8140-525-828	DR AX 0411-GA 2,2UH
L 407	09238-334.01	UKW-SPULE
L 409	07202-636.97	SPULE 7X7
L 411	07202-641.97	SPULE 7X7
L 501	07202-619.97	SPULE 7X7
L 502	19202-159.97	SPULE 7X7 100 FARBE 159
L 504	8140-535-210	SPULE 7X7 210 FARBE 566
L 601	8140-526-419	DR AX 0411-GA 1UH
L 802	8140-526-580	DR -GR 68MH
L 904	8140-525-913	DROSSEL 820 UH +-10% TAY
L 905	07202-371.97	SPULE 7X7

ALTERNATIONS RESERVED

POS. NR.	SACHNUMMER	BEZEICHNUNG 
POS. NO.	PART NUMBER	DESCRIPTION 
 LA 1 LA 2	8316-113-109 8316-113-109	LAMPE T1 5V 60MA 683-1 LAMPE T1 5V 60MA 683-1
 Q 101 Q 102 Q 1001 Q 1101 Q 1102	8382-437-106 8382-251-597 8382-170-433 8382-110-104 8382-200-797	QUARZ 6,275 MHZ QUARZ 54,05 MHZ QUARZ 4,332 MHZ QUARZ 4,194304MHZ SCHWINGQUARZ 32,768 KHZ
 R 500 R 533 R 603 R 605 R 648 R 651 R 656 R 748 R 751 R 756	19703-168.00 8792-002-164 8792-002-146 8792-002-135 19703-170.00 19703-169.00 19703-171.00 19703-170.00 19703-169.00 19703-171.00	POTENTIOME.10KOHM AGC/MGC ESTR.S6 100 KOHM LIN ESTR.S6 4,7 KOHM LIN ESTR.S6 1 KOHM LIN POTENTIOMETER /HÖHEN POTENTIOMETER /BASS POTENTIOMETER /LAUTST. POTENTIOMETER /HÖHEN POTENTIOMETER /BASS POTENTIOMETER /LAUTST.

POS. NR.	SACHNUMMER	BEZEICHNUNG 
POS. NO.	PART NUMBER	DESCRIPTION 
R 812 R 813 R 1135	8792-002-164 19703-213.00 8792-002-159	ESTR.S6 100 KOHM LIN POTENTIOMETER /HF PL. ESTR.S6 47 KOHM LIN
 SI 901 	8315-618-002	FS.1,25 A/T
 T 611 T 901 T 903  T 907  T 913 T 1101 T 1106	8303-284-369 8303-287-369 8302-201-371 8303-284-369 8303-274-337 8302-201-368 8302-210-836	TRANS.BC 369 TRANS.BC 369 TRANS.BC 369 TRANS.BC 369 TRANS.BC 337-40 TRANS.BC 368 TRANS.BD 826-16B

SATELLIT 700

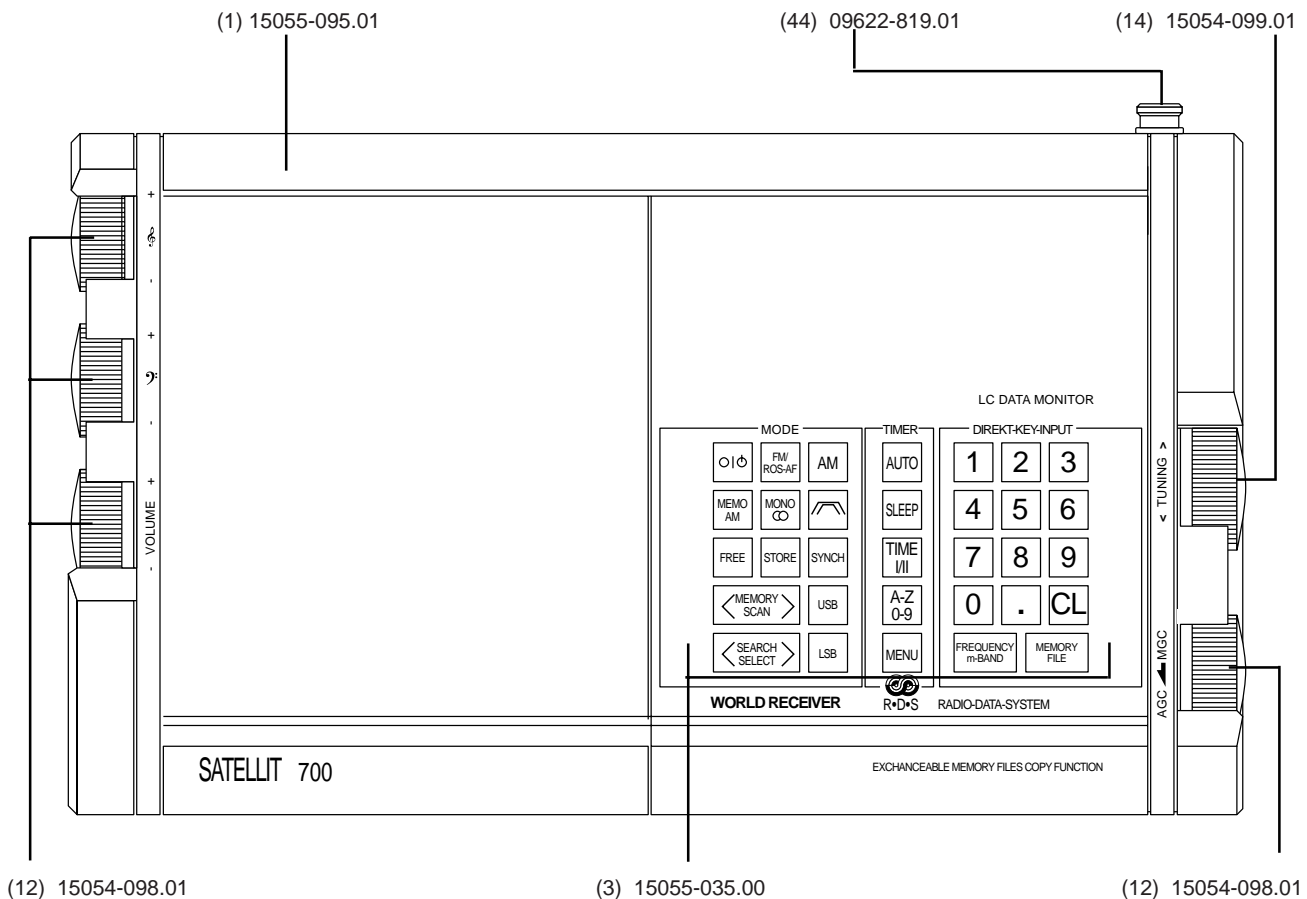

ÄNDERUNGEN VORBEHALTEN

ALTERNATIONS RESERVED